

Protecting Water Quality —

# CONSTRUCTION ON SMALL BUILDING SITES

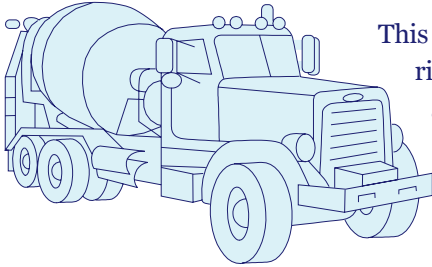

This pamphlet summarizes the regulations and provides guidelines for preventing stormwater pollution associated

with construction activities on small building sites. It is primarily intended to help developers and property owners of projects that disturb less than one acre of land. If your site disturbs one acre or greater, more stringent requirements will apply. See your local permitting agency for details and obtain a copy of the state's regulations for projects disturbing one or more acres at <http://www.swrcb.ca.gov/stormwtr/construction.html>.

Erosion and sediment discharges are visible and environmentally harmful pollutant sources associated with construction sites. Other potential pollutants from construction include paint, concrete residue, stucco, chemicals, and waste materials. Any pollutants that are carried off site in runoff wind up in our creeks and rivers.

***It is illegal to discharge sediment-laden water*** and other construction-related pollutants to the local storm drainage system and waterways.

The property owner is ultimately responsible for preventing water pollution resulting from construction activities, but all involved during construction have a role. Developers, contractors, and property owners are expected to use best management practices (BMPs) to control erosion and the release of sediment and other pollutants. This pamphlet describes various BMPs that can accomplish this.

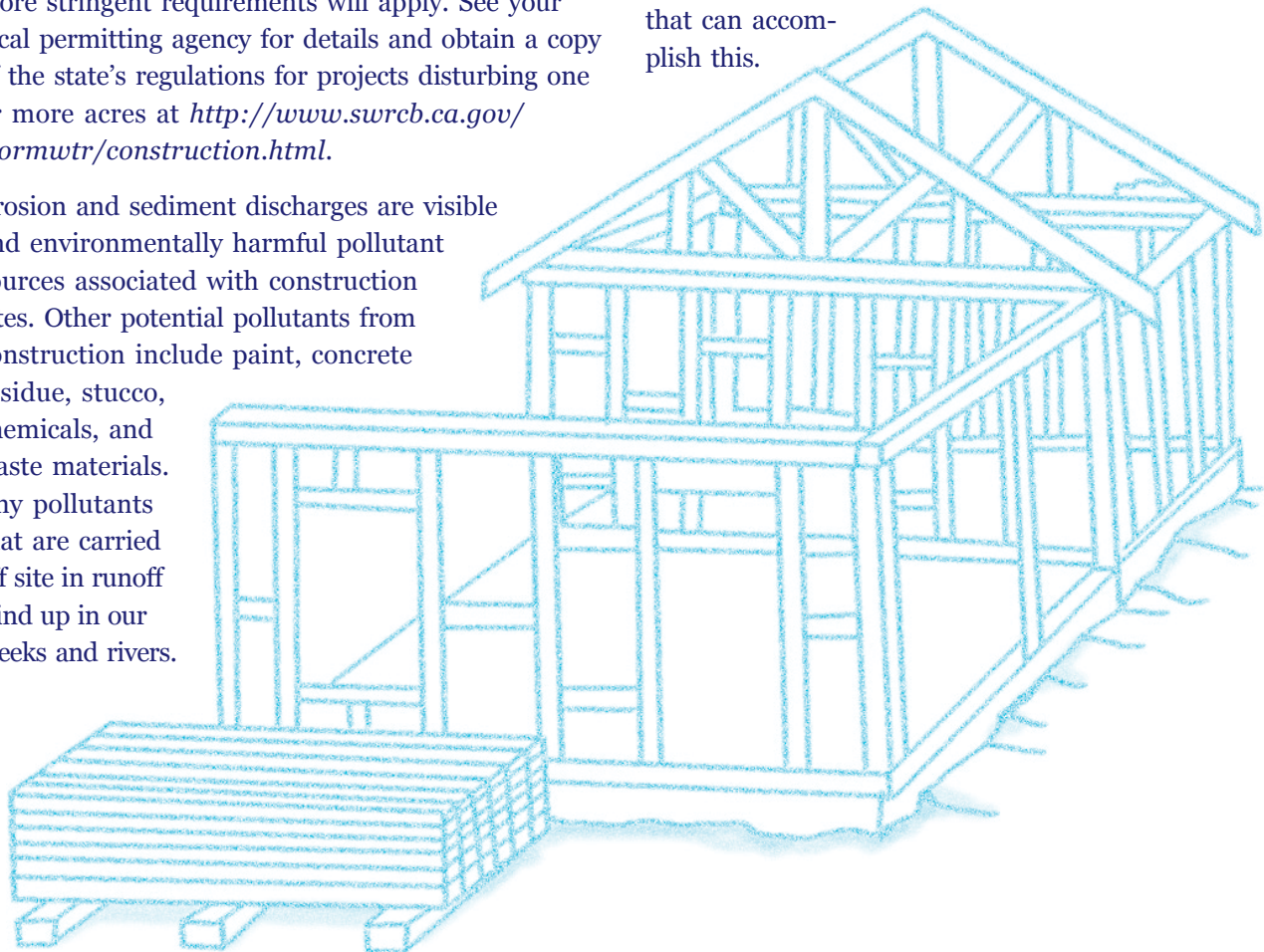

## Pertinent Regulations

### **State Regulations**

State regulations make it illegal for anyone to discharge pollutants into our local creeks and rivers. State regulators will take enforcement action and issue fines to anyone caught polluting waterways. Additionally, the State requires all projects disturbing one acre or more to obtain coverage under the *General Permit for Stormwater Discharges Associated with Construction Activity*. (Previously, this permit applied just to projects disturbing five acres or more.) To find out if your site needs this permit, contact the State Water Resources Control Board at <http://www.swrcb.ca.gov/stormwtr/construction.html> or (916) 341-5536.

### **Local Regulations**

The County of Sacramento and its local cities have adopted laws that make it illegal for anyone to discharge pollutants into a storm drainage system. This

includes sediment and other pollutants which may be present in construction site runoff. Those responsible for prohibited discharges will be cited and can face fines of \$5,000–25,000 per day.

In addition, agencies require an erosion and sediment control plan or similar document for any projects requiring a grading permit. Sites disturbing less than one acre may not require a grading permit. For example, in the City of Sacramento, a project moving 50 cubic yards or more of soil requires a grading permit. See your local permitting agency to determine the requirements applicable to your project.

Whether or not a construction project is required to have a formal erosion and sediment control plan, it is advisable to develop a plan for preventing stormwater pollution from your construction project and implement appropriate BMPs.

## **Why dirt is a problem**

### ***Poor Water Quality***

Sediment is the number one pollutant, by volume, of surface waters in the state of California. It harms water quality by degrading the habitat of aquatic organisms and fish, decreasing recreational uses, and promoting growth of nuisance weeds and algae. It can also reduce the quality of our drinking water.

### ***Increased Flooding***

Sediment accumulation in storm drains, as well as in streams, lakes and rivers, reduces their capacity to contain stormwater which can result in increased instances of flooding during heavy rains.

### ***Higher Local Taxes***

Sediment that finds its way into streets, storm drains, and roadside ditches results in additional maintenance costs for local governments. This increased maintenance cost is passed down to taxpayers in the form of higher taxes or stormwater utility fees.

## Take Steps to Protect Water Quality

Drawing 1 below illustrates an example of the proper placement of some BMPs that can be used to protect water quality from construction activities on a typical small building site.

### 1. Evaluate the Site and Protect Natural Features

#### Locate Water Features and Other Environmentally Sensitive Areas

Determine if there are any existing natural drainage features (e.g., creeks, channels, wetlands, vernal pools) on the site or nearby. Avoid disturbing these areas and designate them with orange protective fencing, or secure the proper permits if you want to alter or otherwise disturb the features.

#### Determine Site Discharge Point(s)

Find out where the site discharges to the local storm drainage system or waterway and contact the responsible agency (listed on the back page) to

familiarize yourself with any additional requirements for discharges into that system.

#### Preserve Natural Vegetation When Possible

Avoid clearing and grubbing the entire site. Preserving vegetation on the site, especially along the perimeter and adjacent to natural water bodies, will help filter and cleanse runoff. Trees, grasses, and shrubs all play a role in improving water quality. To ensure that vegetation is not disturbed or damaged by the contractor, take the following steps:

- Clearly identify all vegetation to be preserved on the plans.
- Fence or flag vegetation to be preserved in the field.
- Place plastic net barriers around the dripline of trees to be preserved (i.e. around the area below the branches); if that area is disturbed, the tree is likely to die.

**Drawing 1: Example site plan showing BMP locations**

Every building site is unique and poses its own potential erosion hazards. Additional or alternative control methods are necessary if the lot is adjacent to a creek, lake, or wetland, or receives run-on from an adjacent area.

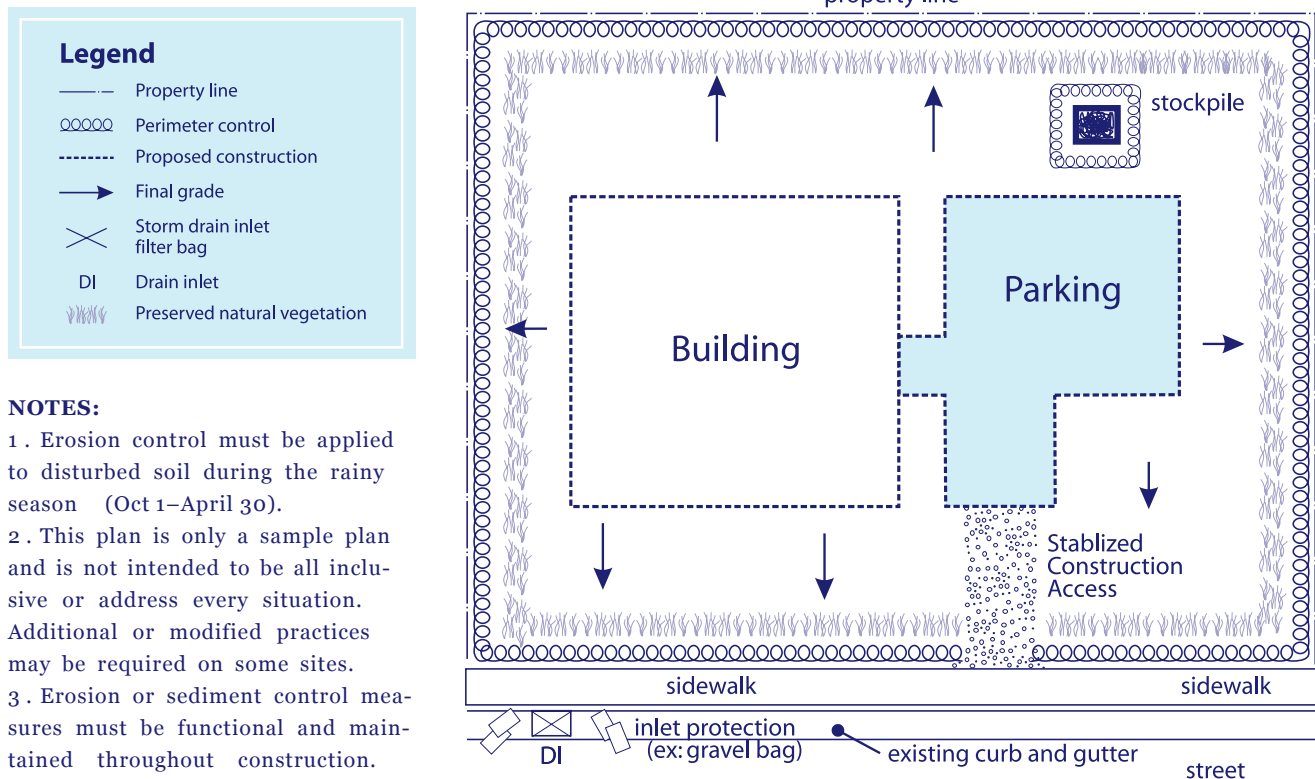

- Do not grade, burn, place soil piles, or park vehicles near trees or in areas marked for preservation.

## 2. Schedule Work to Minimize Problems

- When possible, schedule construction activity — especially grading, during the dry season, from May through September. This is one of the best ways to prevent erosion.
- Sediment control BMPs**, such as drain inlet protection, are required year round.
- Erosion control BMPs** (e.g., soil stabilization) are required *in addition to* sediment controls during the wet season (October 1<sup>st</sup> – April 30<sup>th</sup>).

## 3. Install Perimeter Controls

Determine the BMPs needed to keep sediment from leaving the site, and install them along the site's perimeter **before** any clearing occurs.

Silt fence and fiber rolls are examples of sediment control BMPs that can be used along the perimeter of the site. These devices also work below the toe of exposed and erodible slopes and around temporary soil stockpiles. As with all BMPs, they must be installed correctly and inspected and maintained frequently in order to work properly. See Drawings 2 & 3 for proper installation techniques.

## 4. Install Stabilized Construction Access

Require all construction vehicles and equipment to use one designated, stabilized entrance/exit to prevent vehicles from tracking mud onto roadways. When possible, prohibit vehicle/equipment parking on unpaved or non-stabilized areas. Drawing 4 illustrates a proper stabilized construction access.

## 5. Protect Storm Drain Inlets

Keep sediment from entering storm drains by installing inlet protection devices such as gravel bags

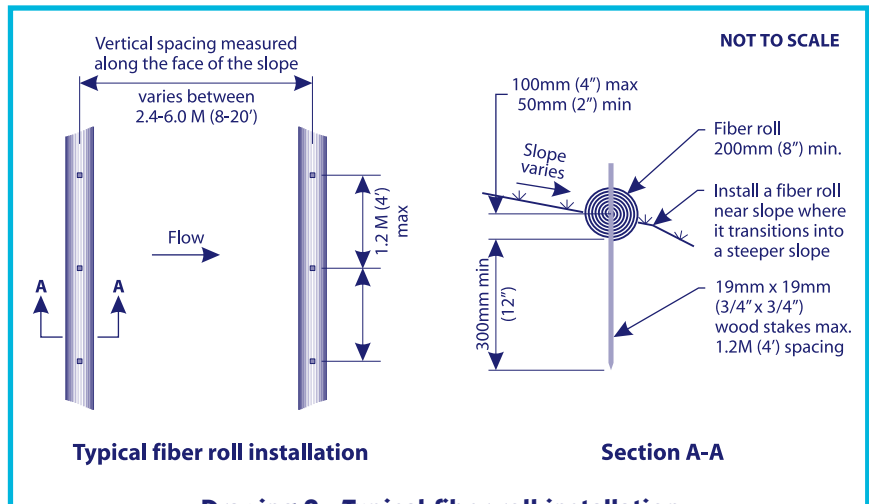

**Drawing 2: Typical fiber roll installation**

and filters on downstream storm drain inlets. These devices are not designed to trap large amounts of sediment and require frequent maintenance to remain effective. **They are not a substitute for perimeter controls.** See drawings 5 and 6 for inlet protection devices.

## 6. Use Other Pollution Control Practices As Needed

### *Apply Rainy Season Erosion Controls*

As mentioned earlier, erosion controls are needed in addition to sediment controls during the wet season (October 1 – April 30). Examples include tackified straw mulch, fiber matrices, and soil binders. Hydroseed should be applied early enough to ensure that vegetation is established before the start of the wet season.

### *Protect Portable Toilets*

Upon delivery, make sure portable toilet(s) are placed on a level surface behind the sidewalk and are located at least 50-100 feet from any storm drain inlet. Anchor portable toilets in areas subject to vandalism or strong winds.

### *Manage Stockpiles Properly*

Designate areas of the site for stockpiles and for the storage of segregated construction waste materials. Locate the materials away from any storm drain inlet, gutter, driveway, stream, wetland, ditch or drainage way. Cover stockpiles and surround with sediment barriers in order to prevent leaching of

the material in runoff. Cover stockpiles prior to windy or rainy weather.

### ***Dewater Without Polluting***

It is illegal to dewater trenches and other areas with sediment-laden water to the storm drainage system, sanitary sewer, or waterway.

Use one of the following options when dewatering:

- Pump water into a portable containment device, and haul it to an approved disposal area.
- Pump water onto a vegetated area of the site for infiltration and filtration.
- Pump water through a filtering device which lowers sediment levels to below 100 mg/l prior to discharging into the storm drainage system.

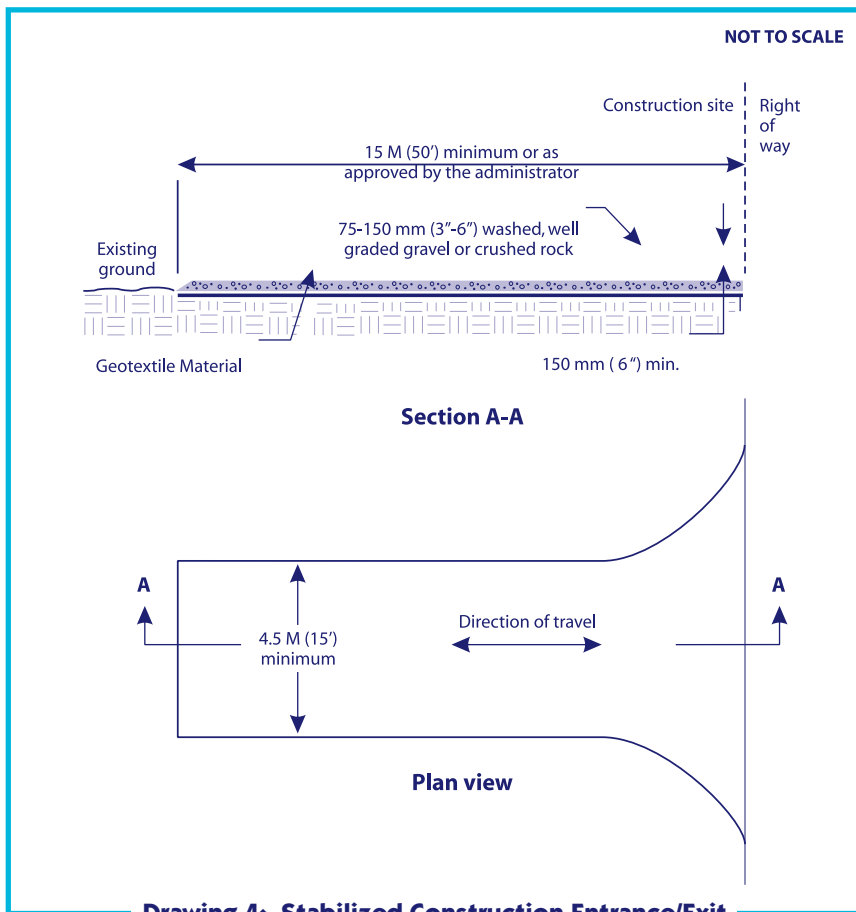
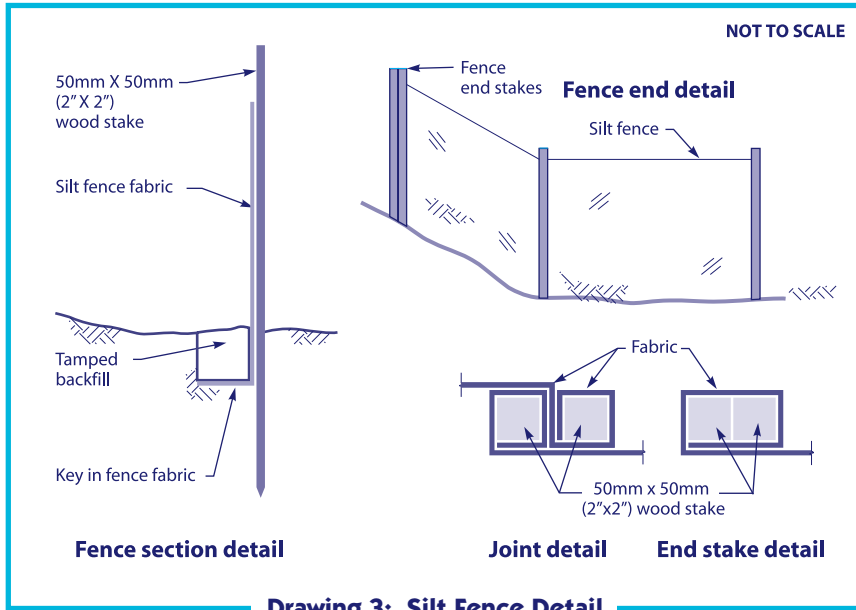

If you are considering discharging to the sanitary sewer, you must contact the local sewer agency. Approval to discharge to the sanitary sewer may include limitations and requirement for treatment, discharge location, and discharge times. See *Contact Information* on the back page to locate the appropriate agency for your location.

### ***Manage and Dispose of All Waste Properly***

Determine the proper disposal methods for liquid and solid waste. Call the responsible local agency, listed on the back of this pamphlet, for acceptable disposal options. If waste bins are used, they should be covered and located away from drainage inlets and gutters.

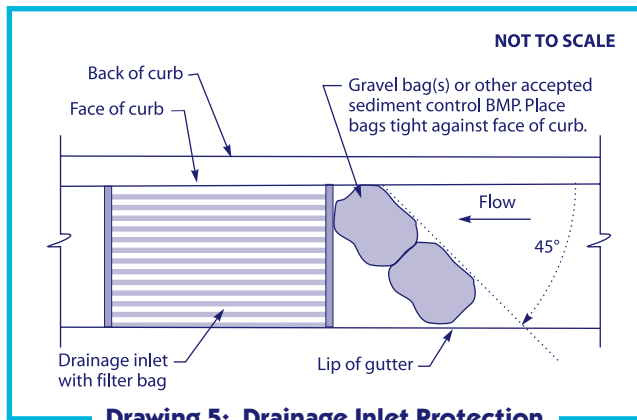

**Drawing 5: Drainage Inlet Protection**

### Properly Handle Concrete Residue

One of the most common prohibited discharges from construction sites is from cleanout operations associated with concrete installations (residue from washing down equipment such as trucks, mixers, chutes, pumps, hand tools, and wheelbarrows).

Keep residue from concrete work from entering storm drains. For example:

- Obtain permission from the property owner to wash out equipment in a dirt area so that the wash water can soak into the ground.
- Place a berm or other barriers to capture water runoff from exposed aggregate, sawing, coring, or mortaring before it reaches the storm drain.
- If necessary, collect washwater into a portable containment device, then haul it to an approved disposal facility. Never wash out wheel barrows, tools, or associated containers near the street. Discharges of these materials to the storm drain are never allowed.
- If you are considering discharging to the sanitary sewer, **you must** contact the local sewer agency. Approval to discharge to the sanitary sewer may include limitations and requirements for

treatment, discharge location, and discharge times. See *Contact Information*.

### Don't Pollute When Painting

Paint, solvents, thinners, and paint-preparation waste may contaminate soil and groundwater if disposed of on the ground or in a septic tank. These chemicals never belong down a storm drain. Take the following steps when using paint:

- Before cleaning brushes, brush out as much paint as possible. Wash water from cleanup of latex paint **ONLY** may be discharged to the sanitary sewer. If the site is not served by the sanitary sewer, the wash water needs to be disposed at a sanitary sewer off-site or disposable tools must be used.
- Never pour excess paint into the storm drain, sanitary sewer, septic tank or on the ground.
- For left over paint, contractors, commercial painters, and residents may recycle latex paint through the Conditionally Exempt Small Quantity Generator Program. See Contact Information on back page.
- Minimize or avoid the use of oil-based paints and thinners.

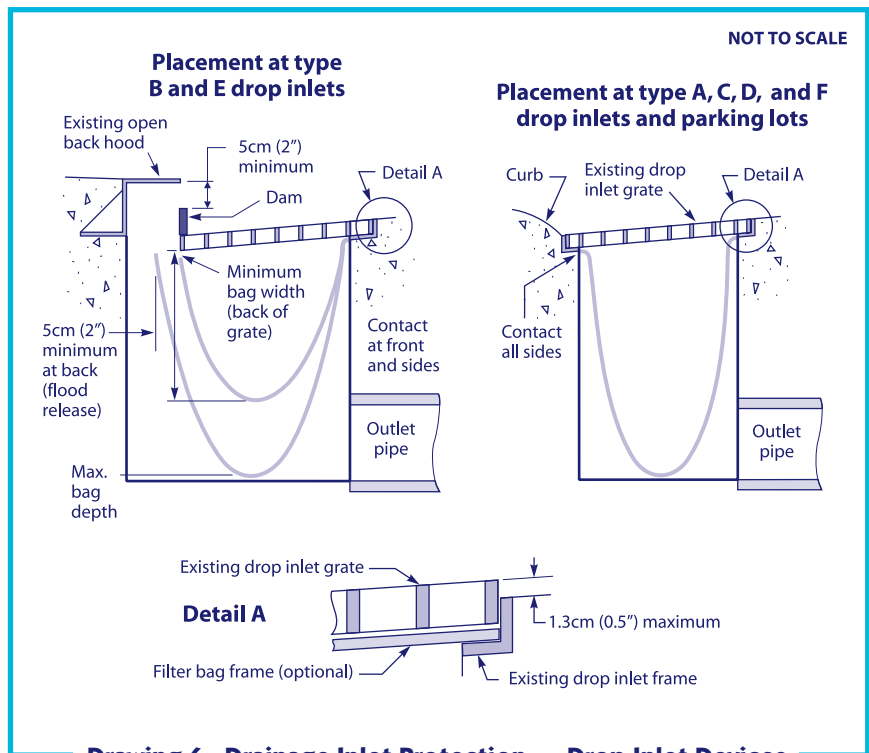

**Drawing 6: Drainage Inlet Protection — Drop Inlet Devices**

## 7. Maintain BMPs

Maintain all BMPs until construction is completed and the lot is stabilized.

- Inspect the BMPs regularly — before and after each rain event, and as necessary to maintain functionality.
- Make any needed repairs immediately. If frequent repairs are needed, consider installing a different or additional BMP.
- Toward the end of each work day, sweep or scrape up any soil tracked onto the street(s). Do not flush streets and gutters with water.

## 8. Perform Final Steps

### *Stabilize the Site*

Immediately after all outside construction activities are completed, spread the stockpiled soil and stabilize all bare areas with sod, seed, and/or mulch.

- Contact local seed suppliers or professional landscaping contractors for recommended seeding mixtures and rates.
- Follow recommendations of a professional landscaping contractor, your supplier, or a professional for installation of sod.
- When watering newly seeded or sodded areas, water only enough to keep the soil moist. Less watering is needed once grass is two inches tall.

### **Make sure everyone knows the rules**

Educate all employees, contractors, sub-contractors and delivery/supply companies about stormwater requirements and the steps they can take to avoid stormwater pollution problems on the project.

- When applying fertilizers or pesticides, read and follow manufacturer's directions and use recommended amounts. Make sure fertilizers and pesticides are not broadcast to impervious surfaces, such as sidewalks or driveways. Never apply fertilizers or pesticides if rain is predicted within 48 hours, or as recommended by the manufacturer. Eliminate runoff from too much irrigation after application. Fertilizers and pesticides are considered pollutants and may end up in our local creeks and rivers.

### **Remove All Temporary Construction BMPs**

Once the sod and/or vegetation are well established, remove all remaining temporary erosion and sediment control BMPs such as storm drain inlet protection devices.

## Additional References

### ***Sacramento Stormwater Management Program Brochures***

The following tri-fold brochures are available free by contacting the County of Sacramento: *Painting Without Polluting*, *Concrete and Creeks Don't Mix*

### ***Erosion and Sediment Control Field Manual (Current Edition)***

This field manual provides useful information on pollution control practices on construction sites. It is available for purchase from Friends of the San Francisco Estuary by calling (510) 622-2419.

### ***Educational Videos (Current Edition)***

Two videos, "Hold Onto Your Dirt" and "Keep It Clean" are available for purchase in English and Spanish from Friends of the San Francisco Estuary by calling (510) 622-2419.

### ***The CASQA (California Stormwater Quality Association) Construction Handbook —***

This handbook provides guidance on developing and implementing Stormwater Pollution Prevention Plans (SWPPPs) and a range of general information about stormwater BMPs and related issues. It is available on-line (for free) at [www.cabmphandbooks.com/Construction.asp](http://www.cabmphandbooks.com/Construction.asp).

# Contact Information

## Stormwater Pollution Prevention Information

Sacramento County (including the City of Rancho Cordova) ..... (916) 874-6851  
City of Sacramento ..... (916) 808-1400  
City of Citrus Heights ..... (916) 727-4769  
City of Elk Grove ..... (916) 478-3636  
City of Folsom ..... (916) 355-7272  
City of Galt ..... (209) 366-7260

## Permits and discharges to the sanitary sewer system

Sacramento Regional County Sanitation District (SRCSD), Industrial Waste Section ... (916) 875-6470  
City of Galt ..... (209) 366-7260

## Sacramento County Business Environmental Resource Center (BERC)

10425 Norden Avenue,  
Mather, CA 95655-1101 ..... (916) 364-4110  
Website ..... [www.sacberc.org](http://www.sacberc.org)

## Hazardous Waste Disposal and Latex Paint Recycling:

Sacramento County, and the Cities of Citrus Heights, Elk Grove, and Rancho Cordova ..... (916) 875-5555  
City of Sacramento ..... (916) 379-0500  
City of Folsom ..... (916) 355-8397  
City of Galt ..... (209) 366-7100

## Building permits

Sacramento County (including the City of Rancho Cordova) ..... (916) 874-6433  
City of Sacramento ..... (916) 808-5656  
City of Citrus Heights ..... (916) 727-4769  
City of Elk Grove ..... (916) 478-2263  
City of Folsom ..... (916) 351-3555  
City of Galt ..... (209) 366-7200

## Website

Visit our website at [www.sacramentostormwater.org](http://www.sacramentostormwater.org)

PLACE  
STAMP  
HERE

