

Natomas Central

Planned Unit Development (PUD) Guidelines

City of Sacramento, California

PUD Established: 10/04/2005

PUD Guideline Revised: N/A

Originating Resolution Number#: R2005-778
(P04-173)

NATOMAS CENTRAL PLANNED UNIT DEVELOPMENT GUIDELINES

4 OCTOBER 2005

DRAFT 5

Prepared for:

K Hovnanian Forecast Homes

Prepared by:



Architecture
Planning
Landscape Architecture
Interior Design
Graphics

2484 Natomas Park Drive, Suite 100
Sacramento, CA 95833
PHONE 916.443.0335
FAX 916.441.2823
WEB www.lpasacramento.com

Table of Contents

INTRODUCTION..... 1

- Purpose
- Location
- Project Description
- Relationship to Existing Plans
- Design Review

PLANNING PRINCIPLES..... 5

- Context
- Site and Peripheral Conditions
- Planning Principles

DEVELOPMENT PLANS 7

- Land Use Plan
- Open Space Plan
- Circulation Plan
- Motorized Vehicles
- Pedestrian and Bicycle
- Bus/Transit

SINGLE FAMILY HOUSING 13

- General Guidelines
- General
- Articulated Elevations
- Materials
- Colors
- Garages
- Trash Storage
- Lot Coverage
- Permitted Uses
- Densities
- Setbacks and Coverage
- Conventional-Shape Lots
- Non-Conventional Shape Lots
- Half-Plex Homes

COTTAGE HOUSING..... 23

- General Guidelines

HIGH DENSITY HOUSING 25

- General Guidelines

Table of Contents

4 OCTOBER 2005 DRAFT 5

PUBLIC FACILITIES	29
• Introduction	
• School	
• Fire	
• Active Adult Recreation Center	
• Parks	
LANDSCAPE DEVELOPMENT	31
• Landscape Master Plan	
• General Landscape Principles	
• Perimeter Plantings	
• Preserve Area	
• Roadway Perimeter	
• Street Trees – Internal Streets	
• Community Entries – Major and Secondary	
• Community Entries – Pedestrian and Bicycle	
• Neighborhood Entries	
• Parking Lots	
• Individual Lots	
WALKS AND TRAILS.....	35
• Peripheral Trail	
• Lake Edge	
• Sidewalks	
• Internal Walks	
SIGNAGE.....	37
• Allowable Signage	
• Major Entry Monuments	
• Individual Project Identification Signage	
• Directional Signage	
LIGHTING	39
• Pedestrian Areas	
• Parking Lots	
• Entry Features	
• Building Lighting	

Table of Contents

FENCING AND WALLS.....	41
• Perimeter Walls	
• Lake Edge Fencing	
• Park Perimeter Fencing	
• Rear Yard Fencing (Typical)	
• Active Adult Community	
APPENDIX	43
• Plant Materials	

I ntroduction

PURPOSE

The purpose of these guidelines is the creation of an aesthetically pleasing community that is safe, diverse and convenient for residents and visitors. These guidelines establish a community vision and enumerate means of attaining that vision. These guidelines address those physical attributes of the community by stressing traditional design, diversity of style and housing types, safe means of movement within the community and the provision of recreation and visual amenities for all community members.

LOCATION

Natomas Central is a comprehensively planned new residential community located in the rapidly expanding North Natomas area of the City of Sacramento California and is situated midway between the Sacramento International Airport and Downtown. The site is west of Interstate 5 and southwest of the intersection of El Centro and Del Paso Roads.

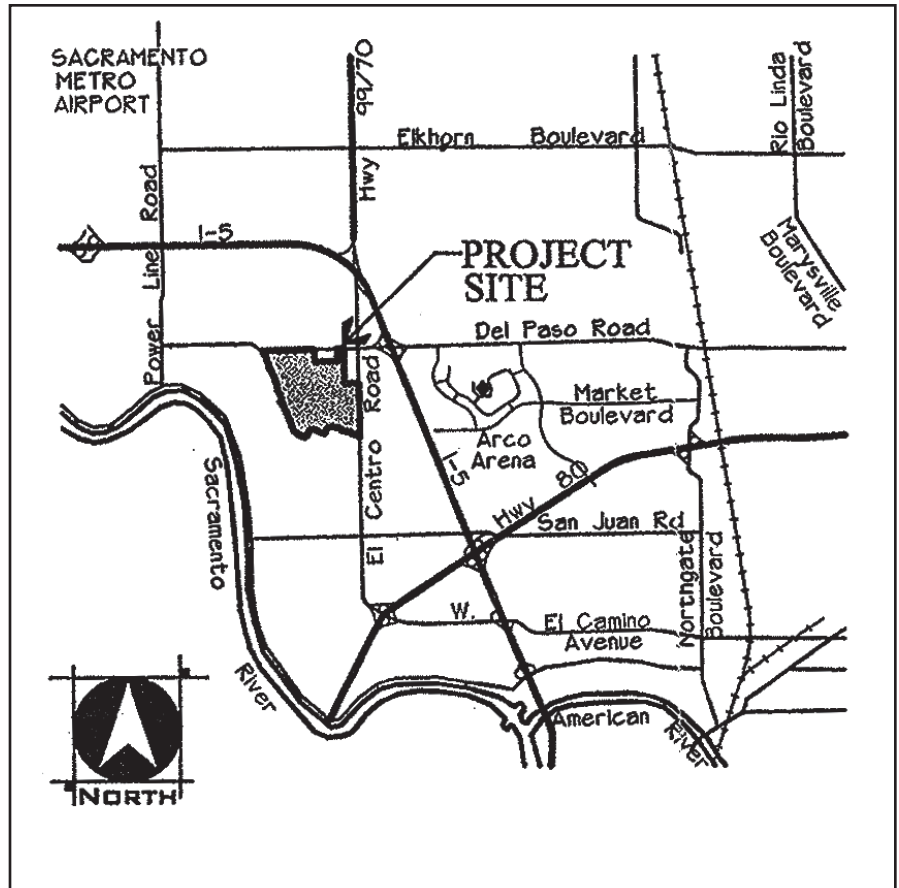

Project Location Map

PROJECT DESCRIPTION

Natomas Central offers two distinct but related housing experiences – first, a traditional new community serving a wide range of residents with varying income levels and family structures and, second, an age-restricted community serving active seniors.

Lago Natomas, a community lake, is the focal point of the community. Community-serving facilities including an elementary school, fire station, parks and an active adult recreation center are envisioned as

I ntroduction

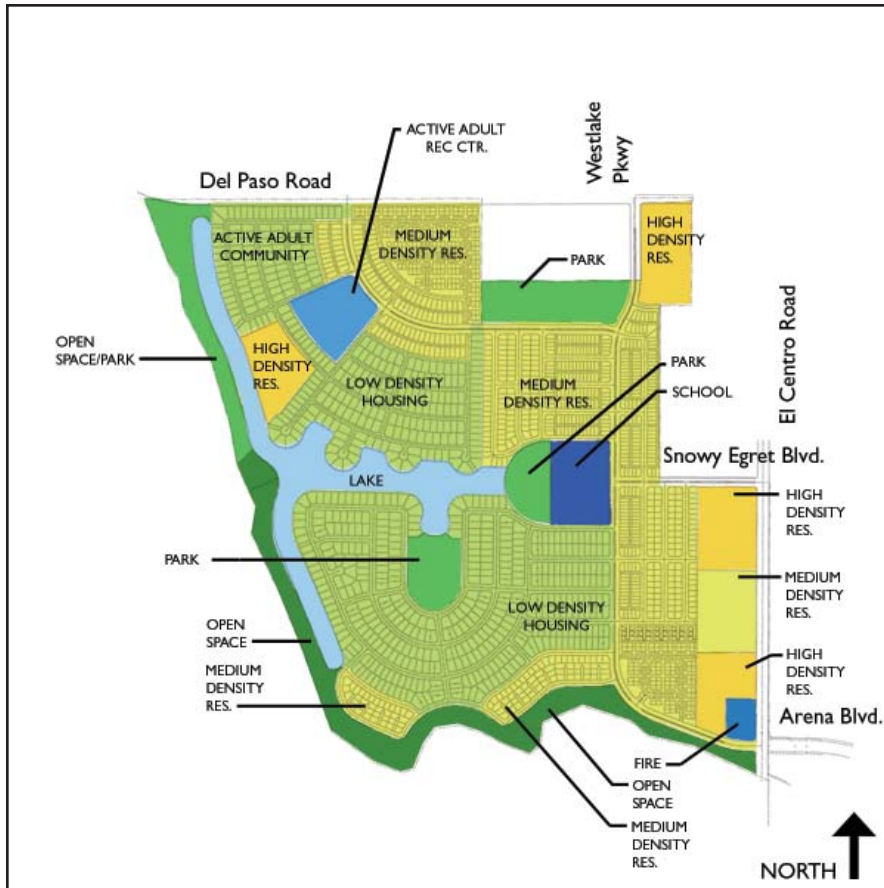

Project Concept

architecturally significant structures whose presence add vitality to the community.

Elegant landscaping and streetscapes, a network of community parks and walks as well as a landscaped edge abutting a permanent open space lends lushness, privacy and exclusivity to this community.

The Natomas Central Plan proposes approximately 1770 single family dwelling units dispersed over 184 acres, approximately 560 high density residential units dispersed over approximately 30 acres, community facilities (elementary school, a fire station, a recreation center) occupying approximately 17 acres, approximately 32 acres of park land, 24 acres of open space and a 29-acre lake. Road rights-of-way comprise the remaining acreage in the project. Total acreage within Natomas Central is 397.9 acres. All of the above acreages are gross acres.

RELATIONSHIP TO EXISTING PLANS

Natomas Central is planned and designed consistent with direction provided by the North Natomas Community Plan, the North Natomas Community Plan Development Guidelines and input by and consultation with City of Sacramento Planning staff.

The entitlement process for Natomas Central includes simultaneous amendments to the City's General Plan, Zoning Ordinance and to the North Natomas Community Plan, creating consistency among these three major policy documents.

I ntroduction

DESIGN REVIEW

In order to assure that high and consistent standards are maintained, the Natomas Central Design Review Committee (NCDRC) has been established.

The purpose NCDRC is to provide design input and approval of design issues relating to development within Natomas Central. In the approval process, the NCDRC shall adhere to these Guidelines. On issues not addressed within these Guidelines, existing City of Sacramento codes, regulations and policies shall apply.

The NCDRC shall be created by the Natomas Central Master Declaration of Covenants, Conditions and Restrictions and shall be responsible for determining compliance with the Guidelines and future adopted standards.

Two types of entitlement requests – planning entitlement or building permit – initiate the design review process. During the formal submission to the City of Sacramento for either of these two types of entitlement, a submission to the NCDRC is required. Detailed submission requirements and schedules shall be determined by the NCDRC and made available to applicants.

I ntroduction

4 OCTOBER 2005 DRAFT 5

P lanning Principles

CONTEXT

Natomas Central is located at the western extremity of the area known as North Natomas. To guide development within this area, the City of Sacramento developed and adopted a master plan known as the North Natomas Community Plan.

Natomas Central is located within an historic floodplain of the Sacramento River. The Sacramento River was channelized to avoid future inundations and the lands within the historic inundation area remained in agricultural uses including grazing and rice production. Remnants of old drainage patterns, rich in wildlife diversity, abut Natomas Central.

Open space, in the form of permanent habitat, is adjacent to Natomas Central to the south and west of the development. The lands east and north of Natomas Central are being developed as part of the City of Sacramento's northward expansion.

SITE AND PERIPHERAL CONDITIONS

The most important peripheral condition is the area contained within the jurisdiction of the Natomas Basin Habitat Conservation Plan (NBHCP). The lands within the plan's jurisdiction are set aside for the protection of important wildlife species and present an impenetrable physical barrier to the west. Although access to the NBHCP area is limited, the NBHCP area is physically off-limits. Its scenic value is a visual resource for the residents of Natomas Central and for the entire Natomas Community.

PLANNING PRINCIPLES

The following planning and design issues have been identified as important and these Guidelines address each issue.

- Compatibility with surrounding development. The developed areas surrounding Natomas Central are a mixture of residential and commercial uses. These Guidelines address materials, styles, housing product types, landscape treatments and community edges in a manner consistent with the vision of the North Natomas Community Plan.
- Creation of a distinctive look and feel for Natomas Central. The look of the community shall reflect an overall Mediterranean-style/ Spanish Revival theme that is prevalent throughout North

Natomas. Other types/themes can be approved through the City review process.

- Consistent landscape and entry treatments, signage and housing styles. Muted colors, simple landscape treatments and a shared material palette establish an understated consistency throughout the community.

- Minimal impact on the adjacent Habitat Conservation Plan area. All development within Natomas Central shall be setback from the Natomas Basin Habitat Conservation Area by means of fencing, parks and/or open space. A trail will traverse the perimeter open space system and provide visual access to this rich environmental resource. This trail system provides opportunities for partnering with educational institutions and environmental groups for interpretative programs.

- Incorporation of storm water drainage as a lake amenity. The flat terrain of the North Natomas area requires innovative drainage solutions. The creation of Lago Natomas incorporates needed drainage within the community.

- Maintenance of high quality lake water. Advanced storm water treatment ensures a continued high quality of lake water suitable for recreational uses and as a visual amenity.

- Provision of a community pedestrian and bicycle network. A trail system linking the peripheral park and open space with Lago Natomas has been created to provide internal circulation as well as to access to the city and region-wide open space networks.

- Establishment of an active adult community within Natomas Central. A stand-alone seniors community will be established to address the need for housing and a sense of community for our elders.

- Provision of housing for an economically diverse community. Natomas Central contains both single and multi-family housing addressing a wide range of economic needs and desires.

- Inclusion of community-serving facilities. Contained within Natomas Central are an elementary school, parks, seniors' recreation center and a fire station.

Development Plans

A summary of the Natomas Central master plan is listed below.

LAND USE PLAN

The land uses within Natomas Central follow the requirements and general layout mandated by the North Natomas Community Plan. The table below summarizes land use within Natomas Central.

LAND USE	ACREAGE	DENSITY**	UNITS
Low Density Housing	99.2*	7.1 du/ac	703
Medium Density Housing	85*	12.6 du/ac	1,069
High Density Housing	29.2*	19.1 du/ac	559
Community Facilities	17*		
Parks	32.2*		
Open Space	23.6*		
Lake	28.9*		
Landscape Corridor	.1*		
Landscape Lot	1*		
Major Roads	9.5*		
Local Residential Streets	72.2*		
TOTALS	397.9		2,331

* Net acreage

** Average Net Density

Development Plans

4 OCTOBER 2005 DRAFT 5



General Land Use Plan

Development Plans

OPEN SPACE PLAN

Two types of open space are provided within Natomas Central – peripheral open space adjacent to the Natomas Basin Habitat Conservation Plan (NBHCP) area and internal open spaces. The two types of open space are interconnected.

The peripheral open space consists of a landscape buffer between residential portions of Natomas Central and the lands of the NBHCP. This buffer consists of both native and non-native species and shall serve as a transition between developed and non-developed areas. Recreational uses within this buffer may consist only of trails, benches, interpretative signage and wildlife viewing areas. Portions of Lago Natomas is within this area.



Open Space Plan

A pedestrian/bicycle path and natural landscape open space/ passive park is planned for the western edge of the property, from Del Paso Road south to its boundary with the peripheral open space at Lago Natomas.

The internal open space system consists of Lago Natomas, school yards and parks distributed among the neighborhoods within Natomas Central. Recreational uses within the internal open space system shall include Lago Natomas and its lakefront walk, active play areas, fields, an active adult recreation center and other recreational activities deemed appropriate.

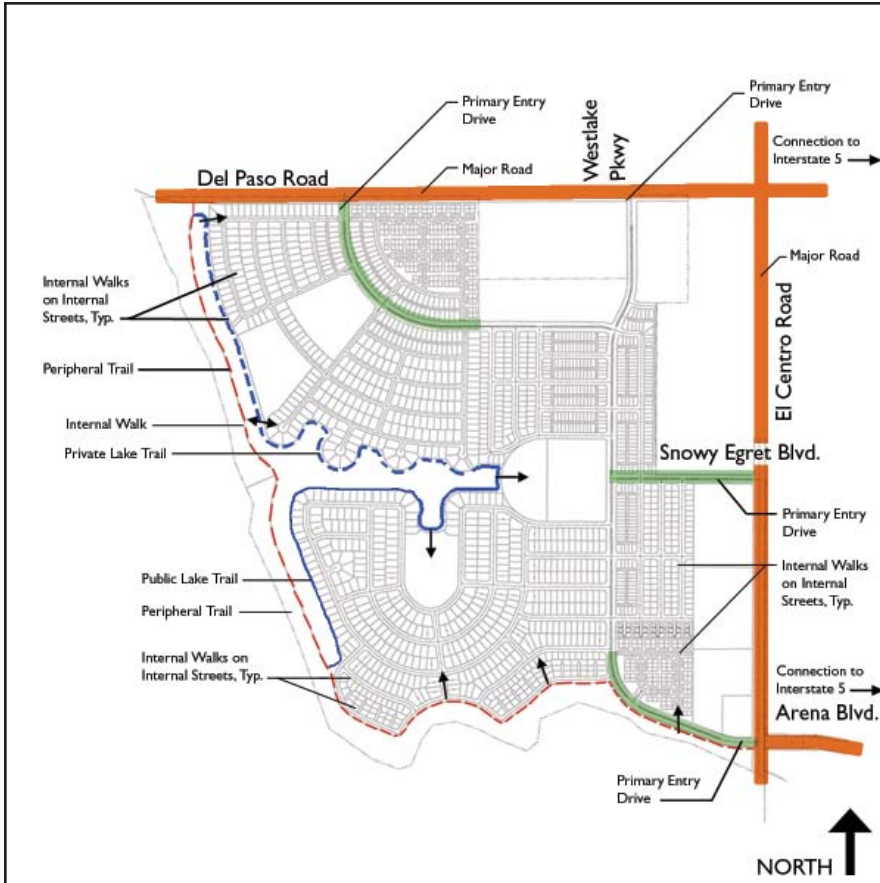

Major Circulation Diagram

CIRCULATION PLAN

The Natomas Central comprehensive circulation plan addresses both motorized and non-motorized circulation.

Motorized Vehicles

The roadway network within Natomas Central is based on the City of Sacramento’s pedestrian-oriented street standards, except within the active adult community where the streets may vary from city standards and will be privately maintained. The roadway network is hierarchical in its form – local streets feeding into community-serving collectors which, in turn, feed into regional-serving arterial streets.

At the terminus of certain streets within the gated age-restricted community are located landscaped emergency vehicle access points.

These access points require paving, fencing, removable bollards and landscaping.

Pedestrian and Bicycles

The pedestrian and non-motorized vehicular circulation plan includes both dedicated walkways, off street trail, sidewalks and the streets. The internal non-motorized circulation system serves both recreation and circulation needs. This internal pedestrian and non-motorized circulation system is connected to external walks and bike paths linking adjoining areas and regional destinations.

Development Plans

Bus/Transit

Bus service shall be coordinated with Regional Transit (RT) to assure reliable and timely connections to the rest of the regional transportation network. A future expansion of RT's light rail system to serve the North Natomas area will be accessible from, but not necessarily adjacent to Natomas Central.

Development Plans

4 OCTOBER 2005 DRAFT 5

Single Family Housing

LOW AND MEDIUM DENSITY RESIDENTIAL

GENERAL GUIDELINES

Single-family housing is the predominant land use within Natomas Central, accounting for approximately 63% of the property. The visual and community aspects of this type of housing are addressed in the following pages.

Single Family Design Guidelines consist of general, over-arching guidelines applicable to all single family units and those particular to each type or density.

Review and approval of all single family house plans will be subject to a Planning Director's Special Permit (PDSP).

The following guidelines apply:

General

- The same house plan, or closely similar elevation, may not be placed on two adjacent or consecutive lots.
- All visible elevations shall be made interesting by means of articulation of facades, varied roof lines, window placement and shape, and variety in exterior colors, finishes and detailing.

Articulated Elevations

- Use of roof overhangs, porches, balconies, trellises, patios, low walls and other items are encouraged to add interest to street elevations.
- Enhanced side and rear elevations shall be required whenever those elevations face a public or private streets, park, school, lake or other public space.
- Rear and side elevations must match front elevations in terms of window treatments, roof lines and materials.
- Roof lines may be made interesting by use of elements such as gables, hips, dormers and roof planes that create variations in planes.



Interesting Roof Lines

Single Family Housing

LOW AND MEDIUM DENSITY RESIDENTIAL

4 OCTOBER 2005 DRAFT 5

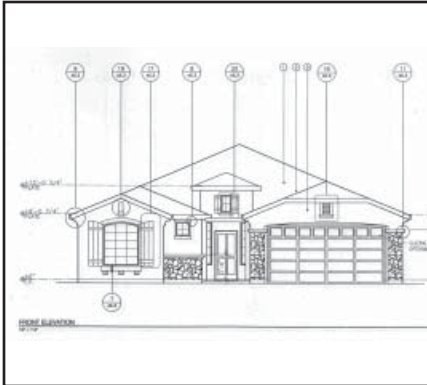

High Quality Materials

- For historical architectural styles (i.e. Tudor, Spanish, etc.) details and articulation must match the character of that period. A balcony that is appropriate on a Spanish-revival style house is not appropriate on a Tudor-revival style house.

Materials

- Use of high quality materials such as stucco, brick, stone and wood is encouraged.
- Accent materials may include stone veneer, painted wood trim, and shutters.
- T-111 siding is prohibited.
- Roofing shall be concrete tile or composition shingle.



Front Façade with Rear Loaded Garages Detached Garage

Colors

- The body color shall be the predominant color and shall be approved by the Planning Commission or Planning Director.
- The trim color shall be a contrasting color in the same family and may be darker or lighter, depending on the body color.
- The accent color shall be used for highlighting details of house and is encouraged to be a dark color complimenting the body and trim colors.

Garages

- Variety in garage configurations is encouraged to avoid having the garage dominate the front of the house.
- Garage configurations may include the following:
 - Attached – rear loaded.
 - Recessed garage – recessed at least feet from front of house. This configuration reduces the impact to the street.

Single Family Housing

LOW AND MEDIUM DENSITY RESIDENTIAL

- Side-loaded – garage doors are oriented perpendicular to the front of the house. This configuration reduces the impact to the street.
- Flushed/Forward – garage is located in line or forward of house by no more than three (3) feet. In this case, prominent covered porches are encouraged.
- Detached – garage is detached from the house and is located toward the back of the lot. This configuration reduces the impact to the street.

Trash Storage

- All trash, recycle, and green waste containers shall be screened from view of streets.

Single Family Housing

LOW AND MEDIUM DENSITY RESIDENTIAL

4 OCTOBER 2005 DRAFT 5

PERMITTED USES

Permitted uses within low-density and medium-density areas of the Natomas Central PUD will include single-family detached homes (including large lots, standard lots, petite lots, flag lots, zero-lot-lines, Z-shaped, zipper, pull apart townhomes and alley lots), single-family attached homes, patio homes, duplex homes, halfplex homes, second residential units (“granny flats”), townhouses, condominiums, and any other uses permitted by City ordinances, resolutions or other policies.

DENSITIES

The mix of residential opportunities within the Natomas Central PUD will meet the needs of a broad range of people on the socio-economic scale. Residential neighborhoods will be safe for residents, particularly for children; quiet and buffered from noise and other nuisance factors; convenient in terms of access to schools, services and shopping; and pedestrian-friendly.

A specific number of units is assigned to each parcel. As detailed plans are prepared and final subdivision maps are submitted, the actual number of units may vary from what is shown on the Land Use Plan on page 7.

To achieve a diversity of housing types and creativity in architecture, densities and lot sizes may vary within substantial conformance for each village. Provided the overall the Natomas Central PUD unit count is not exceeded, given the approved map, then within each single-family residential village, lot densities may vary up to twenty (20) percent above or below the approved number of units; without obtaining a re-zone or amending these PUD Guidelines. A revised tentative map may be required.

Alternatives to conventional lots are permitted within areas designated as low or medium density provided that such alternatives must be approved through the appropriate methods. These design alternatives may include, but not be limited to, attached and/or clustered development types, duplexes or halfplexes, townhomes, petite lots, courtyard lots, cottage lots and wide-shallow lots.

SETBACKS AND COVERAGE

Setbacks will vary for maximum flexibility, but with a goal of creating a comfortable street edge for pedestrians. Setbacks are designed so porches are encouraged to bring the “social” part of the home closer to the sidewalk.

Single Family Housing

LOW AND MEDIUM DENSITY RESIDENTIAL

The goal of these Guidelines is to reduce the visual impact of garages on the streetscape, consistent with other goals such as diversity of housing type, and taking into account the special design considerations that may be required for various types of lots.

The above goal may be accomplished by a variety of means including but not limited to: garages which are detached or attached at or near the rear of units or lots; garages which are set back equal to or behind the non-garage facade or porch; units with forward garages which also include courtyards, arbors, arches or similar treatments to enhance the streetscape; or side-turned garages.

It is recognized that there are special circumstances in which it may not be possible or desirable to design units with recessed garages, in which case alternative treatments, including some listed above (i.e. courtyards, side-turned garages) shall be encouraged. It is also recognized that there can be a diversity of designs on a street. For example, some residential units with recessed garages some units with courtyards, some units with porches, and some units with garages forward.

CONVENTIONAL-SHAPE LOTS

The goal is to bring homes closer to the street while maintaining a comfortable street edge. For conventional lots (including, but not limited to: 45' x 105', 50'x105', 52'x105', 55'x105', 60'x105' and 62x105'), the following setbacks are allowed.

Porch:

12' 6" minimum from back of walk or back of curb, whichever is closer.

Front of Building:

12' 6" minimum from back of walk or back of curb, whichever is closer.

Sideward:

5'-0" minimum on each side, with the exception of zero-lot line conditions, which shall be 5'-0" and 0". Garages and/or accessory dwelling units which are recessed a minimum of 50' from the street may have a 0'-0" side yard setback.

Rear Yard:

The recommended setback is 15'-0" minimum. Detached garages and accessory dwelling units ("granny flats"), if recessed a minimum of 50' from the street, may have a 0'-0" rear yard setback.

Single Family Housing

LOW AND MEDIUM DENSITY RESIDENTIAL

may have 0'-0" side yard and rear yard setbacks if structure is recessed a minimum of 50' from street. The goal is to have an attractive design without intruding on neighbors.

Projections and Bays:

Bays and projections will be permitted to encroach up to 3'-0" into the front yard setback, and up to 2'-0" into the side yard setback and 3'-0" into the rear yard setback.

Height:

35'-0" Maximum.

Garage/Parking:

Each home shall have an attached or detached 1, 2 or 3 car garage.

Coverage:

Lot coverage shall not exceed 50 percent for single and two story homes, given the following allowances/incentives:

-Covered porches in the front or street side do not count toward the maximum lot coverage.

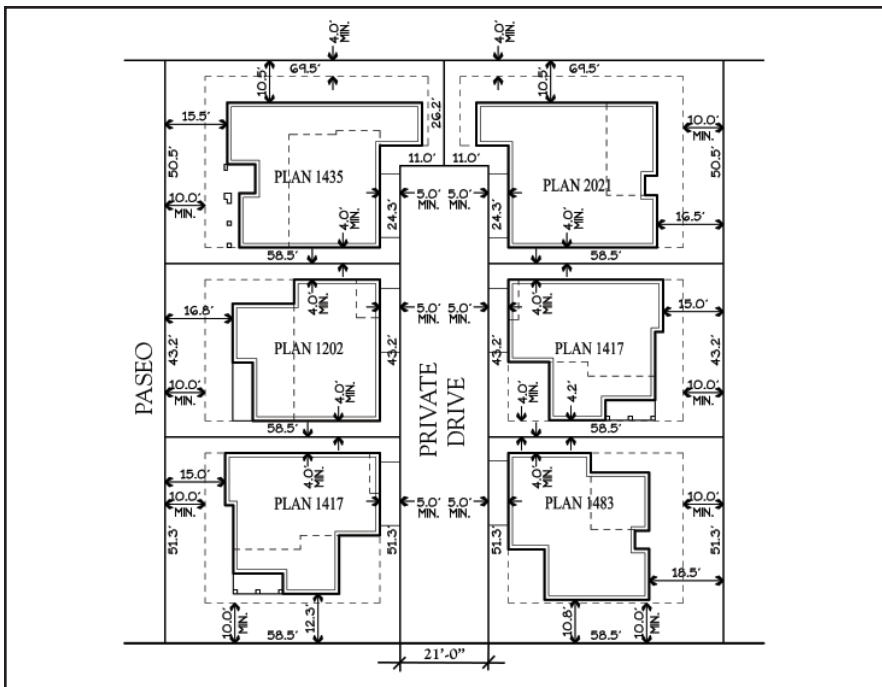

-Attached or detached garages that are recessed a minimum of four feet from the living area of the home (not the porch) count 50 percent toward the maximum lot coverage.

-At the homeowner's discretion, an additional 100 square feet of accessory structure(s) may be built on the lot.

Courtyard Housing

Single Family Housing

LOW AND MEDIUM DENSITY RESIDENTIAL

COURTYARD HOUSING

Description:

These homes share private drives with five or six other homes. Typical lot size is 43' x 58'-6", although lot sizes may vary. Homes are detached and on single family lots. Home size ranges from 1,200 to 2,020 sf.

Porch:

10'-0" minimum from property line (paseo side).
10'-0" minimum from public street.

Front of Building:

10'-0" minimum from property line (paseo side).
10'-0" minimum from public street

Side Yard:

3'-0" minimum on each side, with the exception of zero-lot line conditions, which shall be 5'-0" and 0".

Rear Yard:

4'-0" minimum from private drive to living area.

Garage Setbacks:

4'-0" minimum from private drive.

Projections and Bays:

Bays and projections will be permitted to encroach up to 3'-0" into the front yard setback, and up to 2'-0" into the side yard setback and 3'-0" into the rear yard setback.

Landscaping:

Front and rear yards shall be fully landscaped.

Coverage:

Lot coverage shall not exceed 50 percent for single and two story homes, given the following allowances/incentives:

-Covered porches in the front or street side do not count toward the maximum lot coverage.

-Attached or detached garages that are recessed a minimum of four feet from the living area of the home (not the porch) count 50 percent toward the maximum lot coverage.



Typical Paseo Front Façade

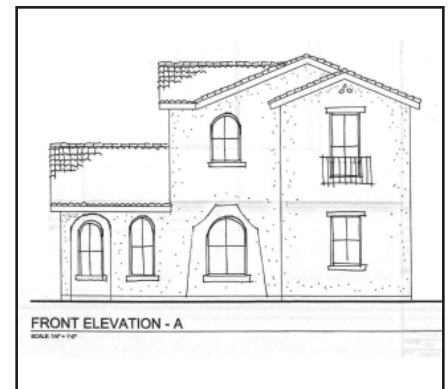

Typical Paseo Front Façade

Single Family Housing

LOW AND MEDIUM DENSITY RESIDENTIAL

4 OCTOBER 2005 DRAFT 5

-At the homeowner's discretion, an additional 100 square feet of accessory structure(s) may be built on the lot.

HALF-PLEX HOMES

Description:

Co-joined homes located on corners within single-family neighborhoods. They are similar in scale and design as the single-family units located adjacent to these units. Their corner orientation mandates high levels of detailing on both the front and street-facing elevations. Typical lot size is 45' x 105', although dimensions may vary. Unit sizes range from 1,250 to 1,850 sf.

Duplex/Halfplex development within Natomas Central is subject to Zoning Code requirements.

Duplex/Halfplex development may be approved with a Planning Director Special Permit.

Minimum Setbacks:

Subject to minimum setbacks for non-conventional shape lots.

Entries:

Entries for each unit of the half-plex shall be on different streets.

Driveways:

The driveways shall be located away from the intersection of the streets.

Coverage:

Lot coverage shall not exceed 50 percent for single and two story homes, given the following allowances/incentives:

-Covered porches in the front or street side do not count toward the maximum lot coverage.

-Attached or detached garages that are recessed a minimum of four feet from the living area of the home (not the porch) count 50 percent toward the maximum lot coverage.

-At the homeowner's discretion, an additional 100 square feet of accessory structure(s) may be built on the lot.

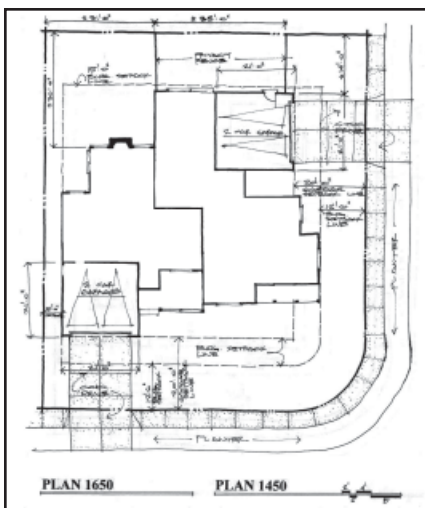

Half Plex Lot

Cottage Housing

GENERAL GUIDELINES

Description:

Cottage lots provide alternative housing opportunities through the use of small lots, common open space and detached, clustered parking. Two-story homes are offered. Home size ranges from 750 to 1,300 sf. Homes may have a zero-lot line configuration.

Minimum Setbacks

Porch:

0' from property line

Front of Building:

0' from property line

Side Yard:

3'-0" minimum on each side, with the exception of zero-lot line conditions, which shall be 5'-0" and 0". Garages and/or accessory dwelling units which are recessed a minimum of 50' from the street may have a 0'-0" side yard setback.

Rear Yard:

5' 0" minimum

Garage Setbacks:

Not applicable

Accessory Structures:

Subject to Building Code, accessory structures, detached garages and carports shall be permitted.

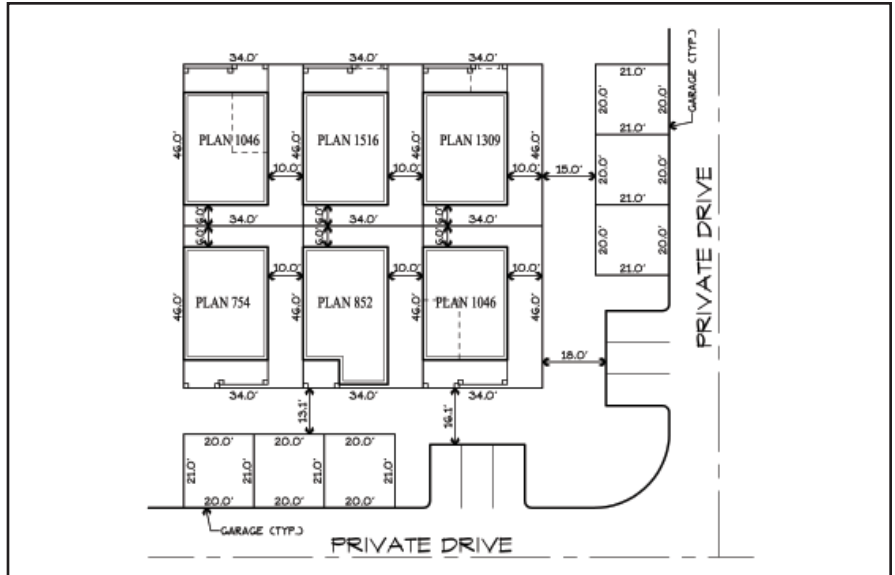

Cottage Lots

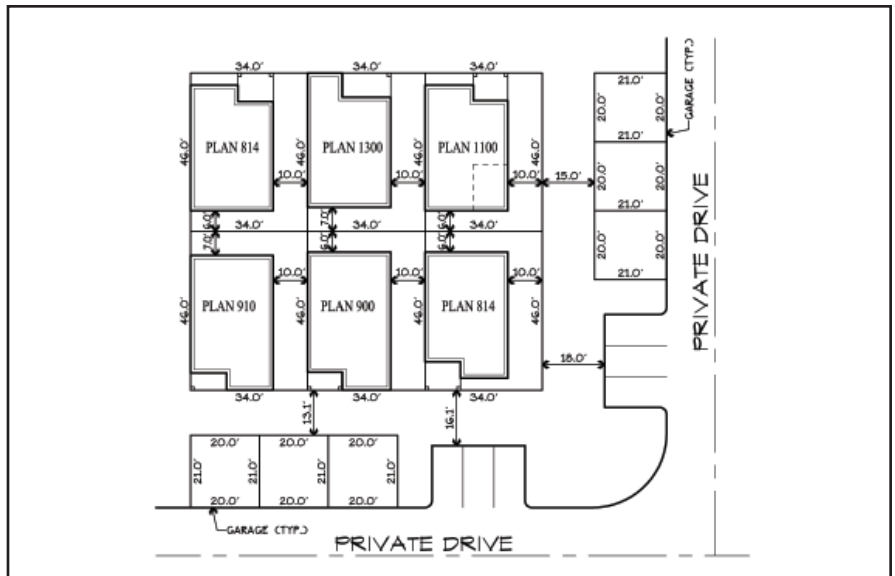

Hathaway Lots

Cottage Housing

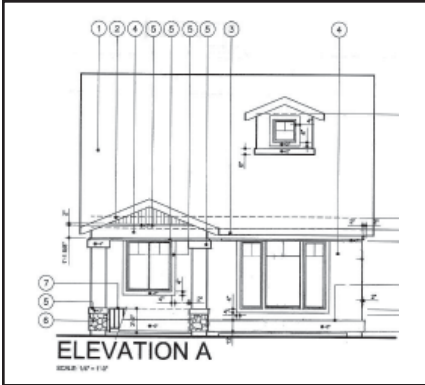

Typical Front Façade

Projection and Bays:

Bays and projections will be permitted to encroach up to 3'-0" into the front yard setback, and up to 2'-0" into the side yard setback and 3'-0" into the rear yard setback.

Maximum Height:

35'-0"

Garage/Parking:

A carport or garage shall be provided for each unit, and may be clustered in groups. Carports and/or garages shall be of the same architectural vocabulary as the buildings. Guest parking shall be located in close proximity to each unit.



Typical Front Façade

Coverage:

Lot coverage shall not exceed 75 percent for single and two story homes, given the following allowance/incentive:

- Covered porches in the front or street side do not count toward the maximum lot coverage.

Materials:

Primary building material shall be stucco. Accent materials include stone veneer, lap siding, clay tile, and stucco. Roofing is typically concrete tile or composition shingle.

H igh Density Housing

GENERAL GUIDELINES

High density housing within Natomas Central consists of four parcels totaling approximately 30 acres in size. Target densities for high density residential is 22 du/ac. Age restricted developments and zoned high density may have densities up to 36 du/ac.

The City of Sacramento's Multi-Family Residential Principles provide the underlying guidelines for this section and should be consulted when planning and designing high-density housing in the City. The guidelines provided below shall take precedence over the City's, if in conflict.

General

- All visible elevations shall be made interesting by means of articulation of facades, varied roof lines, window placement and shape, and variety in exterior colors, finishes and detailing.
- Architectural styles may depart from that of single family development.
- Multi-family developments along El Centro Road and Del Paso Road may be gated with the approval of a Planning Commission Special Permit (Code Section 17.76.05B).

Minimum Building and Landscape Setbacks

- 15' setback along street frontages.
- 5' at internal property lines. No setback is required between buildings, except as required by the building code.akjfljlkf
- Building and landscape setback requirements adjacent to single family residential development shall be determined upon the review and approval of a proposed development for a particular HDR site.

Heights

- Natomas Central HDR site should be consistent with Westborough PUD. Maximum of 3 stories and 35 feet. Architectural projections such as tower elements, chimneys, cupolas, may project an additional 10 feet.



Conceptual Elevation

The high density residential site located within the age-restricted community may exceed the standard height restriction of HDR zoning if developed with podium parking. In buildings where podium parking is provided, height may be measured from the top of the podium. Maximum height shall not exceed 50'-0".

Massing and Layout

- Open space amenities are encouraged as a means to help create a community within the greater Natomas Central community.
- Patios and courtyards are encouraged between buildings. Rooflines shall be varied. Entries shall be prominent from the street.

Articulated Elevations

- Enhanced side and rear elevations shall be required whenever those elevations face a public street, park, school, lake or other public space.
- Rear and side elevations must match front elevations in terms of window treatments, roof lines and materials.
- For historical architectural styles (i.e. Tudor, Spanish, etc.) details and articulation must match the character of that period.

Materials

- Building materials may consist of stucco, cement plaster, wood, metal and glazing. Accent materials may be wood, glazing, canvas, metals, brick, and stone.

H igh Density Housing

- Roofing may be concrete tile, or flat with parapet walls.
- T-111 siding is prohibited.

Colors

- Colors will be determined at the time of project review.

Garage/Parking

- Open structured parking is permitted, either as an integral part of a building or as a stand-alone structure. Grouped, clustered, and surface parking is allowed. Tandem parking is permitted.
- Parking required for Seniors High Density Residential is one parking space per unit, plus guest parking at one per 15 units.
- Refer to the City of Sacramento standards for required parking for multi-family housing.

Enclosed Yards

- On street-facing elevations, no fencing or walls shall be allowed between buildings and the street. Fencing and screen walls are allowed between buildings.
- Each dwelling unit shall have a usable outdoor space designed for the exclusive use of that dwelling unit. The outdoor space may be at grade or provided as a balcony. Patios and balconies should be directly accessible from buildings and be of such size as to offer a reasonable outdoor living opportunity.
- Patios and balconies shall not be used for permanent storage. Temporary storage must be screened from public view.

Landscaping

- All non-paved areas shall be landscaped.

Lighting

- Light fixtures and poles shall be consistent throughout the HDR zone.
- Building illumination and architectural lighting shall be indirect. Floodlights are prohibited.
- Use of low level lighting to enhance architecture, landscape or other features is encouraged.
- Architectural lighting should articulate the building design as well as provide functional lighting for the safety of pedestrian movement.

Storage, Refuse, Loading and Service Areas

- Storage, refuse, loading and service areas shall be screened from public view.
- Service areas shall be screened from view by building design, layout, and masonry walls or by a combination of walls, landscape and berms.
- Refuse collection areas are to be designed to ensure that refuse and refuse containers are not visible from public viewing areas – streets, entries and amenity areas.
- Refuse collection areas shall be designed with the same materials, finishes, and colors as the adjacent building(s). Solid metal gates shall be provided.

Trash enclosures shall not be permitted within the street side setback.

Utility Screening

- All ground mounted utilities shall be screened through the use of walls, plant materials, or berms. Specific clearances must be followed as required by each utility.

Public Facilities

INTRODUCTION

Public facilities including an elementary school, fire station, active adult recreation center, and parks are provided within Natomas Central. These facilities address health, safety and welfare aspects of the community.

As these public facilities are important places within the community, the design of these facilities should be bold in form with entries embracing the street. Awnings, pergolas, roof overhangs and other shade-creating devices are encouraged.

SCHOOL

A 8.0 acre site is reserved for an elementary school. The Natomas Unified School District is encouraged to work closely with the Natomas Central Design Review Committee and the City's Department of Parks and Recreation when designing this facility.

FIRE

A site on El Centro Road is set aside for a fire station. Like the school, the fire station serves an important civic and safety role in the community. Reflecting their role in the community, the design of this facility should impart both a sense of respect and openness.

ACTIVE ADULT RECREATION CENTER

The active adult recreation center will be located within the active adult community.



Public Facilities Locations



Community Park

PARKS

These parks, totaling 32 acres, are proposed for Natomas Central. Two of the parks are located adjacent to Lago Natomas and the third is located adjacent to the existing middle school at the north end of Natomas Central. Although not dedicated as a park, approximately 24 acres of perimeter buffer open space is also provided.

Landscape Development

The Guidelines recognize that a mature landscape is of great importance to the unity and character of Natomas Central. Landscaping shall be one of the primary unifying elements within Natomas Central.

LANDSCAPE MASTER PLAN

The elements of a comprehensive landscape master plan are discussed below.

GENERAL LANDSCAPE PRINCIPLES

- The landscape theme, particularly at entries, shall reflect the overall Mediterranean architectural theme of Natomas Central.
- Themed tree plantings along major streets and at entries shall provide visual reference within the community.
- Landscaping along the west and south perimeters shall be a combination of native and non-native species and will provide a transition between the Natomas Basin Habitat Conservation Plan area and residential uses.
- All landscaping shall be continuously preserved and maintained – watering, weeding, fertilizing, spraying, pruning, root aeration and irrigation repair.
- Use of drought tolerant and native plantings shall be encouraged, particularly along the perimeter of Natomas Central, in medians and along pathways.
- Residents are encouraged to use native and drought tolerant plantings to provide habitat and to reduce water consumption.



Landscape Master Plan

PERIMETER PLANTINGS

Two types of perimeters exist at Natomas Central – adjacent to the Natomas Basin Habitat Conservation Plan (NBHCP) area and street frontages along El Centro Road, Del Paso Road and, briefly, along Snowy Egret Boulevard.

Preserve Area

Perimeter plantings adjacent to the NBHCP area are intended to convey the sense of transition between the habitat area and housing contained within Natomas Central. As such, the plantings are a mixture of native and non-native species.

The predominant species of trees shall be those native to riparian areas of the Sacramento area – California Sycamore (*Platanus racemosa*), Western Cottonwood (*Populus fremontii*) and Valley Oak (*Quercus lobata*).

The pedestrian pathway located within the perimeter between housing and the NBHCP area is a convenient and schematic division between the “native” and introduced plant species. West and south of the pathway, all plantings shall be, as much as possible, native. East and north of the pathway plantings shall be a combination of plants native and drought tolerant species not necessarily native to the area.

The ground surface west and south of the pathway shall be planted in native prairie grasses while the area east and north of the pathway shall be planted in a combination of the native grasses used on the west and south sides as well as sprays of drought tolerant species that attract birds and wildlife.

Turf and lawn grasses are discouraged within the perimeter lots, adjacent to the NBHCP area.

Roadway Perimeters

Street trees along El Centro Road and Del Paso Road shall be Zelkova trees *Zelkova serrata* with stretches of Flowering Pear (*Pyrus calleryana*) as accent trees. These trees are selected to reinforce the importance of both roads within the North Natomas area.

Landscape Development

The street tree for Snowy Egret Boulevard and the entry street through the Active Adult Community shall be the London Plane (*Platanus acerifolia* 'Columbia'). Ground level plantings of low mounding, drought tolerant shrubs and native grasses are encouraged. Turf grass may be used only as an extension of turf grass plantings on property adjacent to perimeter plantings.

STREET TREES – INTERNAL STREETS

A plan noting street trees to be used along internal streets shall be included as part of special permit package.

COMMUNITY ENTRIES – MAJOR AND SECONDARY

Major entries are located along Del Paso Road and on El Centro Road at the intersections of Snowy Egret Boulevard and Arena Boulevard. A secondary entry is located on Del Paso road, west of the existing school.

Enhanced landscape treatment is required at all entries into and out of Natomas Central. The enhanced landscape treatment shall compliment Natomas Central street tree plantings, signage and overall design themes. The Fruitless Olive (*Olea europaea* 'Wilsoni') shall be the theme tree at entries.

All landscaping and plantings shall conform to City of Sacramento standards for sight line requirements at intersections and driveways.

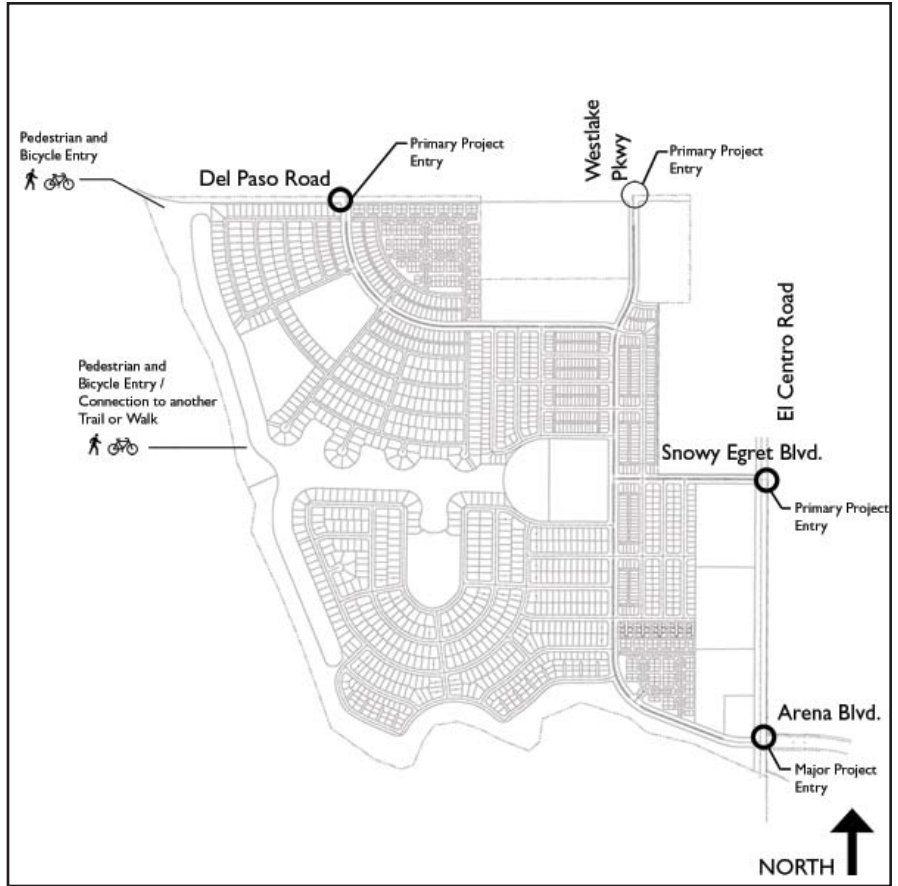

Entry Locations

COMMUNITY ENTRIES – PEDESTRIAN AND BICYCLE

Connections between and among the peripheral open space trail, the western park and the Lago Natomas walk shall be treated as gateways. These gateways shall incorporate olive trees.

NEIGHBORHOOD ENTRIES

If gated street entries are permitted into and out of the active adult community, as well as high density housing developments, these gated entries shall have enhanced landscape treatments at levels consistent with other neighborhood entries.

All landscaping and plantings shall conform to City of Sacramento standards for sight line requirements at intersections and driveways.

PARKING LOTS

All parking lot landscaping shall conform to the City of Sacramento's Parking Lot Tree Shading and Maintenance Design Guidelines in effect at

the time of building permit application. The intent of the City's parking lot tree shading guidelines is to require all new parking lots to include tree plantings designed to result in 50 percent shading of parking lot surface areas within 15 years.

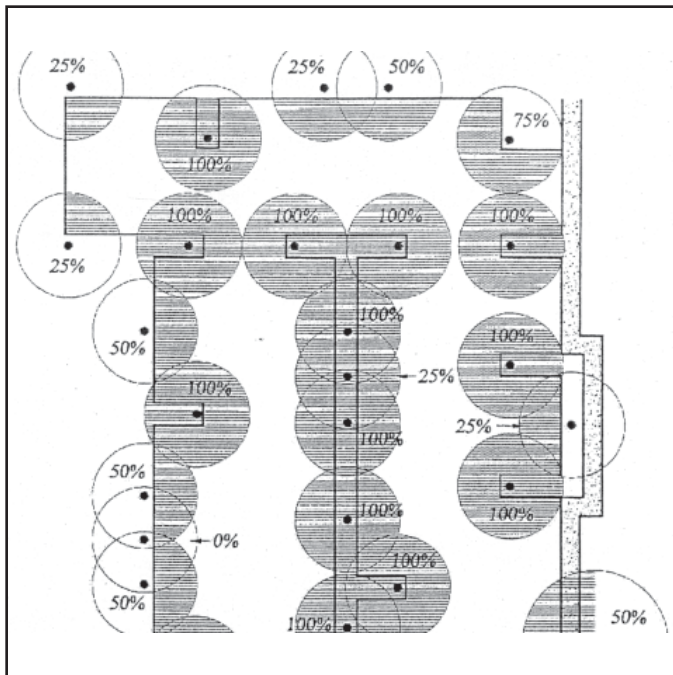

Parking Lot Landscape

INDIVIDUAL LOTS

The builder shall provide front yard landscaping and irrigation. Front yard landscaping shall consist of at least one deciduous tree; minimum 15 gallon size, and at least eight feet tall in height.

On corner lots, the builder shall provide special landscaping treatments by providing accent trees and shrubs along the side yard fence.

Walks and Trails

Pedestrian and bicycle circulation is an important community-serving component of Natomas Central. Internal circulation that is efficient, safe and attractive contributes to the well-being of the community by offering opportunities for interaction among community members as well as providing opportunities for walking, running and bicycling within, among and adjacent to residential areas, community facilities and employment areas.

PERIPHERAL TRAIL

The peripheral trail in the setback area between Natomas Central residential areas and the Natomas Basin Habitat Conservation Plan area shall be constructed as per the City's Multi-Use Trail Design Guidelines. The multi-use trail shall be a total of sixteen (16) feet wide including twelve (12) feet of asphalt pavement with a two (2) foot wide decomposed granite shoulder on each side or as determined by the City PPDD. The trail shall be located as close to roadways on the south and the detention basin on the west as possible, with some landscaping between the trail and the streets.

LAKE EDGE

A concrete walk, fifteen (15) feet in width, shall ring the perimeter of Lago Natomas. A portion of the trail shall be publicly accessible and connect to on-street sidewalks. Fencing is permitted on the housing side of the walk only and shall be subject to the guidelines provided in the Fencing and Walls section of these guidelines. The duration of lighting along the lake walk shall be determined by the community association(s) and posted directly adjacent to the lake walk.



Lake Edge Walk

SIDEWALKS

Sidewalks, designed in accordance with City of Sacramento design standards shall be provided on all public streets.

INTERNAL WALKS

Internal walks and street access points allowing access to Lago Natomas and city streets in the senior community shall be constructed in accordance with the City's Multi-Use Trail Design Guidelines. The multi-use trail shall be a total of sixteen (16) feet wide including twelve (12)

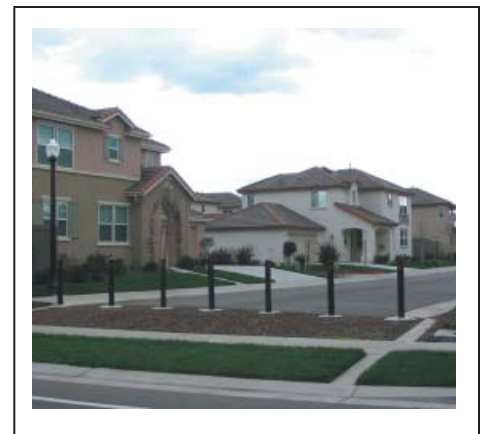

Emergency Vehicle Access Points

W alks and Trails

4 OCTOBER 2005 DRAFT 5

feet of asphalt pavement with a two (2) foot wide decomposed granite shoulder on each side or as determined by the City's PPDD. Internal walks shall be lighted for pedestrian safety.

Signage

The purpose of signage guidelines is to create a family and vocabulary of signage appropriate for Natomas Central. A comprehensive signage design package shall be approved by the Planning Director.

ALLOWABLE SIGNAGE

Allowable major signage in Natomas Central includes Project Identification Monuments, Village Identification Signage and Directional Signage. Project signage for community facilities, high density housing, and directional signage are also permitted.

MAJOR ENTRY MONUMENTS

Major entries are located along Del Paso Road and on El Centro Road at the intersections of Snowy Egret Boulevard and Arena Boulevard.

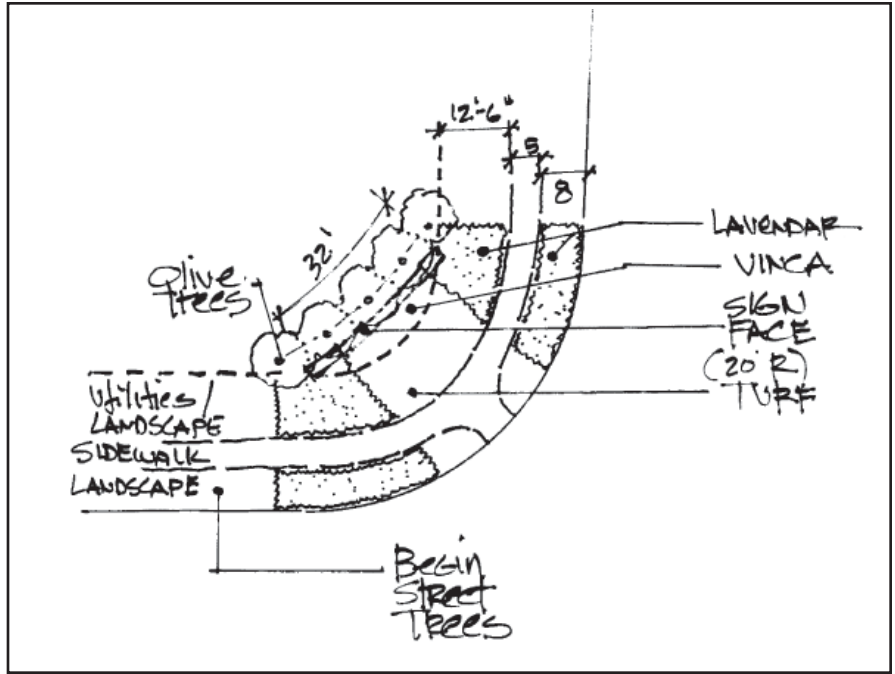

Major Entry Monument- Plan View

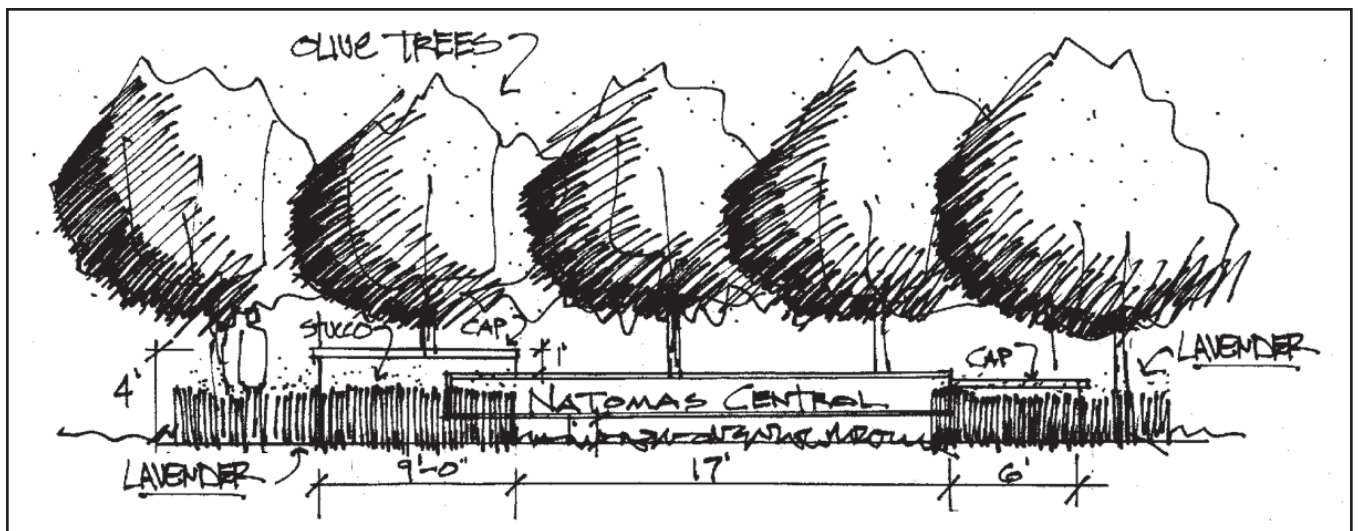

Major Entry Monument- Elevation

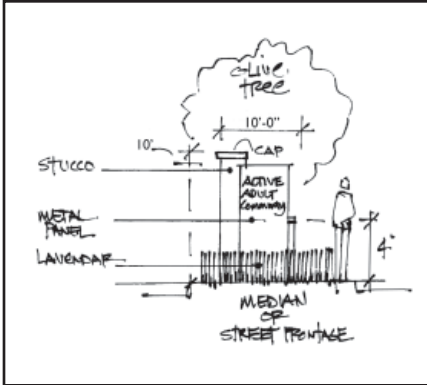

Project Identification Signage

INDIVIDUAL PROJECT IDENTIFICATION SIGNAGE

Individual projects within Natomas Central may have 1 ground mounted sign at each primary entry. Signs shall not exceed ten (10) feet in height and ten (10) feet in length. Sign face may not exceed 100 feet in size. Innovative lighting and design is encouraged.

DIRECTIONAL SIGNAGE

Directional signage is to be located at or near intersections. Directional signage shall consist of internally lit pylons, columns or panels with attached plates bearing the name and direction of the destination. The maximum height of the directional signs may not exceed eight (8) feet in height. The columns, pylons or panels may be internally lighted or from ground-mounted lights.

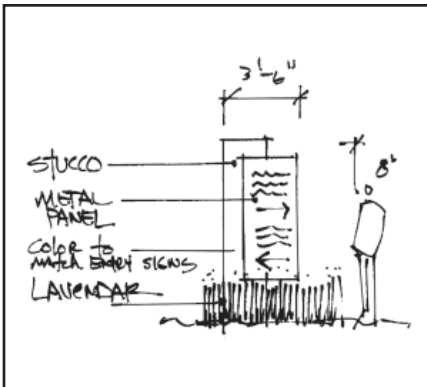

Directional Signage

Lighting serves multiple purposes within Natomas Central. The primary uses are for public safety, place marking of important buildings, features and entries, way finding and as part of design aesthetics for landscapes, buildings and signage.

PEDESTRIAN AREAS

All paved pedestrian areas shall be lighted. Lighting within pedestrian areas shall be of the same design style. Pedestrian lighting may be accomplished by light standards, not exceeding 15 feet in height, bollards or suspended overhead lights. Pole mounted lighting shall be the Nyhavn Post Pole style, manufactured by Louis Poulsen. The bollard shall be the Waterfront bollard, also manufactured by Louis Poulsen. The aesthetic goal of the pedestrian lighting is to create horizontal bands of light winding through the landscape. Pole and fixture color to be white.

PARKING LOTS

All parking lot lighting shall be metal halide. Parking lot light standard and fixtures and standards shall be consistent along El Centro Road. Lighting height may vary and will be determined with the project special permit.

ENTRY FEATURES

Entry features feature ground-mounted and internal light sources.

BUILDING LIGHTING

Security lighting in the High Density Housing areas may not extend above the fascia or roofline of the building. Security lighting is not to be substituted for pedestrian or parking lot lighting.

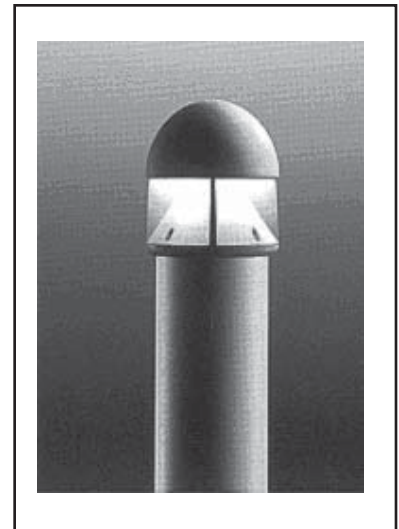

Bollard Light



Pedestrian Light

L ighting

4 OCTOBER 2005 DRAFT 5

Fencing and Walls

PERIMETER WALLS

Perimeter walls can be erected behind single family housing El Centro and Del Paso Roads. The walls shall be a maximum of six (6) feet in height and shall be built of integrally-colored split-face masonry block and shall be divided along its length by columns or pilasters not more than 100 feet on center. A wall cap shall be provided. Painting of these walls is discouraged. Graffiti abatement steps such as landscaping or the application of a sacrificial coating may be applied.

LAKE EDGE FENCING

Semi-transparent fencing made of painted tubular steel is required for the rear lot lines of all residences and uses fronting Lago Natomas. The fencing, four feet in height, shall be mounted on a low concrete wall, two (2) feet in height, for a total height of six (6) feet. A painted tubular steel gate and steps or a ramp shall be provided for each property. Fence and gate color shall be painted black. No opaque surfaces other than landscaping may block visibility through the fence.

PARK PERIMETER FENCING

- Four-foot tubular steel fencing shall be required for park areas fronting streets and Lago Natomas.
- Vertical curbs shall be required for all park areas fronting streets.
- Split-face masonry block walls shall be required on all residential lots backing or siding on park sites.
- Fencing adjacent to parks and open space shall be reviewed and approved by Parks and Recreation Department of the City of Sacramento.



Park Perimeter Fencing

REAR YARD FENCING (TYPICAL)

Fencing materials for side and rear yards not visible from the street shall be provided by the builder. The design for perimeter fencing for high density housing and cottage lots shall be designed and submitted for design review approval at the time of special permit application. Wood fencing shall be stained where visible from the street.

ACTIVE ADULT COMMUNITY

The perimeter of the seniors' community facing Del Paso Road shall have a perimeter wall as described in "Perimeter Walls" in this section.

The perimeter fencing for properties fronting the open space buffer area to the west of Natomas Central shall be six (6) foot tall tubular steel fencing. The fencing shall be painted black, to match the lake edge fencing. Gates not are permitted adjacent to the open space buffer area.

PLANT MATERIALS

Large Trees (50'-100')

Water Usage	Botanical Name	Common Name
Medium	<i>Acer saccharum</i>	Sugar Maple
Medium	<i>Acer platanoides</i>	Norway Maple
High	<i>Alnus rhombifolia</i>	White Alder
Medium	<i>Araucaria heterophylla</i>	Norfolk Island Pine
Medium	<i>Catalpa speciosa</i>	Western Catalpa
Low	<i>Celtis australis</i>	European Hackberry
Medium	<i>Ginkgo biloba</i>	Maidenhair Tree
Medium	<i>Gleditsia triacanthos</i>	Honey locust
Medium	<i>Magnolia grandiflora</i>	Southern Magnolia
High	<i>Picea abies</i>	Norway Spruce
High	<i>Picea pungens</i>	Colorado Spruce
Medium	<i>Pinus canariensis</i>	Canary Island Pine
Low	<i>Pistachia chinensis</i>	'Keith Davey' Chinese Pistache
Medium	<i>Platanus acerifolia</i>	London Plane Tree
Medium	<i>Platanus racemosa</i>	California Sycamore
Medium	<i>Populus nigra</i> 'Italica'	Lombardy Poplar
Low	<i>Quercus lobata</i>	Valley Oak
Low	<i>Quercus suber</i>	Cork Oak
Low	<i>Quercus wislizenii</i>	Interior Live Oak
Medium	<i>Quercus robur</i>	English Oak
Medium	<i>Quercus rubra</i>	Red Oak
Medium	<i>Quercus wilensii</i>	Interior Live Oak
Low	<i>Sequoia sempervirens</i>	Coast Redwood
Medium	<i>Ulmus parvifolia</i>	Chinese Elm
Medium	<i>Zelkova serrata</i> 'Green Vase'	Green Vase Zelkova

Medium Trees (30'-50')

Water Usage	Botanical Name	Common Name
Medium	<i>Alnus cordata</i>	Italian Alder
High	<i>Betula jacquemontii</i>	Himalayan Birch
Medium	<i>Carpinus betulus</i>	European Hornbeam
Low	<i>Celtis sinensis</i>	Chinese Hackberry
Low	<i>Ceratonia siliqua</i>	Carob
Low	<i>Cercidum floridum</i>	Blue Palo Verde
Low	<i>Cercis canadensis</i>	Eastern Redbud
Medium	<i>Liquidambar styraciflua</i>	Sweet Gum

A ppendix

4 OCTOBER 2005 DRAFT 5

Medium	Magnolia grandiflora	'St. Marys' Southern Magnolia
Medium	Maytenus boaria	Mayten Tree
Medium	Morus alba 'Fruitless'	Fruitless Mulberry
High	Nyssa sylvatica	Sour Gum
Low	Pinus halepensis	Aleppo Pine
Low	Pinus eldarica	Afghan Pine
Medium	Pinus sylvestris	Scotch Pine
Low	Quercus ilex	Holly Oak
Medium	Sapium sebiferum	Chinese tallow tree
Low	Schinus molle	California Pepper Tree
Medium	Sophora japonica	Pagoda Tree
High	Tilia cordata	Linden
Medium	Umbellularia californica	California Bay

Small Trees (15'-30')

Water Usage	Botanical Name	Common Name
Low	Acacia baileyana	Bailey Acacia
High	Acer ginnala	Amur Maple
High	Acer palmatum	Japanese Maple
Low	Albizia julibrissin	Silk Tree
Medium	Arbutus unedo	Strawberry Tree
Low	Cercis occidentalis	Western Redbud
High	Cornus florida	Eastern Dogwood
Medium	Crataegus laevigata 'Paul's Scarlet'	English Hawthorn
Medium	Crataegus phaenopyrum	Washington Hawthorn
Medium	Eriobotrya deflexa	Bronze Loquat
Medium	Geijera parviflora	Australian Willow
Medium	Koelreuteria paniculata	Golden Rain Tree
Low	Lagerstroemia indica (Indian series)	Crape Myrtle
High	Magnolia soulangiana	Saucer Magnolia
High	Magnolia stellata 'Jane Platt'	Star Magnolia
High	Malus spp.	Snow Crabapple
High	Malus floribunda	Flowering Maple
Medium	Olea europaea 'Wilsoni'	Fruitless Olive
High	Podocarpus gracilior	Fern Pine
High	Prunus serrulata	Flowering Cherry
Low	Prunus lyonii	Catalina Cherry
Medium	Prunus blieriana	Flowering Plum
Medium	Prunus cerasifera	Purple Leaf Plum
Medium	Prunus caroliniana	Carolina Laurel Cherry

Medium	<i>Pyrus kawakami</i>	Evergreen Pear
Low	<i>Raphiolepis</i> x 'Majestic Beauty'	ncn
Low	<i>Rhus lancea</i>	African Sumac

Large Shrubs (6'-15')

Water Usage	Botanical Name	Common Name
High	<i>Abelia grandiflora</i>	Glossy Abelia
Low	<i>Acacia baileyana</i>	Bailey Acacia
High	<i>Aucuba japonica</i>	Japanese Aucuba
Low	<i>Callistemon citrinus</i>	Lemon Bottlebrush
High	<i>Camellia japonica</i>	Camellia
Low	<i>Ceanothus thyrsiflorus</i>	Blue Blossom
High	<i>Cocculus laurifolius</i>	Laurel-leaf Snail seed
High	<i>Cornus stolonifera</i>	Red Twig Dogwood
Low	<i>Cotoneaster lacteus</i>	Parney Cotoneaster
High	<i>Cyperus papyrus</i>	Umbrella Plant
Low	<i>Diosma album</i>	White Breath of Heaven
Low	<i>Diosma pulchrum</i>	Pink Breath of Heaven
Low	<i>Dodonea viscosa</i>	Hopseed Bush
Low	<i>Dodonea viscosa</i> 'Purpurea'	Purple Hopseed Bush
Medium	<i>Escallonia rubra</i>	Escallonia
Low	<i>Euonymus alata</i>	Burning Bush
Medium	<i>Feijoa sellowiana</i>	Pineapple Guava
Medium	<i>Forsythia intermedia</i>	Golden Bells
Medium	<i>Grevillea</i> 'Canberra'	Canberra Grevillea
Low	<i>Heteromeles arbutifolia</i>	Toyon
High	<i>Ilex altaclarensis</i>	Wilson Holly
High	<i>Ilex aquifolium</i> 'San Gabriel'	San Gabriel Holly
Low	<i>Lagerstroemia indica</i>	Crape Myrtle
Low	<i>Laurus nobilis</i>	Grecian Laurel
High	<i>Magnolia stellata</i>	Star Magnolia
Low	<i>Mahonia lomarifolia</i>	Burmese Grape
Medium	<i>Olea europaea</i>	Olive
Medium	<i>Osmanthus fragrans</i>	Sweet Olive
Medium	<i>Phormium tenax</i>	New Zealand Flax
Medium	<i>Photinia fraseri</i>	Red-leaf Photinia
Medium	<i>Photinia serrulata</i>	Chinese Photinia
Medium	<i>Pittosporum crassifolium</i>	ncn
Medium	<i>Pittosporum eugenioides</i>	Tarata
Medium	<i>Pittosporum tobira</i>	Mock Orange
Medium	<i>Pittosporum tenuifolium</i>	Towhiwhi
Medium	<i>Pittosporum undulatum</i>	Victorian Box
Medium	<i>Podocarpus macrophyllus</i>	Yew Pine

Appendix

4 OCTOBER 2005 DRAFT 5

Medium	<i>Prunus cistena</i>	Sand cherry
Medium	<i>Prunus caroliniana</i> 'Bright n' Tight'	Carolina Cherry
Medium	<i>Prunus caroliniana</i> 'Compacta'	Carolina Cherry
Low	<i>Rhamnus alternus</i>	Italian Buckthorn
Low	<i>Rosmarinus officinalis</i>	Rosemary
Medium	<i>Syzygium paniculatum</i>	Brush Cherry

Medium Shrubs (3'-6')

Water Usage	Botanical Name	Common Name
High	<i>Abelia grandiflora</i> 'Sherwoodi'	Pink Abelia
Low	<i>Agapanthus orientalis</i> 'Alba'	Lily-of-the Nile
Low	<i>Arbutus unedo</i> 'Compacta'	Dwarf Strawberry Tree
Low	<i>Berberis</i> spp	Barberry
Medium	<i>Chaenomeles japonica</i>	Flowering Quince
High	<i>Choisya ternata</i>	Mexican Orange
Low	<i>Cistus purpureus</i>	Orchid Rockrose
Low	<i>Citrus limon</i>	Lemon
Low	<i>Echium fastuosum</i>	Pride of Madeira
Medium	<i>Escallonia 'Fradesii'</i>	Escallonia
Medium	<i>Euonymus alata</i> 'Compacta'	Compact Winged Euonymus
High	<i>Gardenia jasminoides</i> 'Mystery'	Mystery Gardenia
Medium	<i>Grevillea 'Noelii'</i>	ncn
High	<i>Ilex crenata</i>	Japanese Holly
Low	<i>Mahonia aquifolium</i>	Oregon Grape
Medium	<i>Myrsine africana</i>	African Boxwood
Low	<i>Nandina domestica</i> 'Compacta'	Dwarf Heavenly Bamboo
Low	<i>Nandina domestica</i>	Heavenly Bamboo
Medium	<i>Phormium tenax</i> 'Maori Chief'	New Zealand Flax
Medium	<i>Pittosporum tobira</i> 'Variegata'	Tobira
High	<i>Potentilla fruticosa</i>	Cinquefoil
High	<i>Prunus laurocerasus</i> 'Zabeliana'	Zabel's Cherry Laurel
Medium	<i>Prunus glandulosa</i>	Flowering Almond
Low	<i>Raphiolepis indica</i>	India Hawthorn
High	<i>Rosa californica</i>	Rose
Low	<i>Rosmarinus officinalis</i>	Rosemary
Low	<i>Salvia clevelandii</i>	ncn
Low	<i>Salvia greggii</i>	ncn
Low	<i>Salvia leucantha</i>	Mexican Bush Sage
Medium	<i>Sarcococca ruscifolia</i>	ncn

Medium	<i>Spirea bumalda</i>	ncn
Medium	<i>Spirea thunbergii</i>	ncn
Medium	<i>Spirea vanhouttei</i>	ncn
Medium	<i>Strelitzia nicolai</i>	Giant Bird of Paradise
Medium	<i>Strelitzia reginae</i>	Bird of Paradise
Low	<i>Viburnum tinus</i> 'Spring Bouquet'	ncn
Low	<i>Xylosma congestum</i> 'Compacta'	Shiny Xylosma

Small Shrubs (below 3')

Water Usage	Botanical Name	Common Name
High	<i>Abelia grandiflora</i> 'Prostrata'	White Abelia
Low	<i>Agapanthus orientalis</i> 'Peter Pan'	Dwarf Lily-of-the Nile
High	<i>Azalea indica</i>	Azalea
Low	<i>Eriogonum fasciculatum</i>	California Buckwheat
High	<i>Gardenia jasminoides</i> 'Little Gem'	Gardenia
High	<i>Iris douglasiana</i>	Douglas Iris
Low	<i>Lavandula</i> spp	Lavender
Medium	<i>Limonium perezii</i>	Statice
Low	<i>Mahonia aquifolium</i> 'Compacta'	Dwarf Oregon Grape
Low	<i>Myrtus communis</i> 'Compacta'	Dwarf Roman Myrtle
Low	<i>Nandina domestica</i> 'Harbor Dwarf'	Dwarf Heavenly Bamboo
Medium	<i>Phormium tenax</i> 'Jack Spratt'	New Zealand Flax
Medium	<i>Pittosporum tobira</i> 'Wheeler's Dwarf'	ncn
Medium	<i>Spirea nipponica</i>	
Low	<i>Teucrium chamaedrys</i>	ncn
Low	<i>Tulbaghia violacea</i> 'Variegata'	Society Garlic

Ground Covers

Water Usage	Botanical Name	Common Name
Low	<i>Arctostaphylos</i> 'Emerald Carpet'	ncn
Medium	<i>Arctotheca calendula</i>	Cape Weed
High	<i>Campanula poscharskyana</i>	Bellflower
Low	<i>Cerastium tomentosum</i>	Snow-In-Summer
Medium	<i>Ceratostigma plumbaginoides</i>	

Appendix

Low	<i>Cotoneaster apiculatus</i>	
Low	<i>Cotoneaster horizonatalis</i>	Rock Cotoneaster
Medium	<i>Euonymus fortunei</i> 'Minima'	
Medium	<i>Euonymus fortunei</i>	
Low	<i>Festuca californica</i>	
Low	<i>Festuca ovina</i> 'Glauca'	
High	<i>Fragaria chiloensis</i>	Ornamental Strawberry
Low	<i>Gazania</i>	
Medium	<i>Hemerocallis</i> sp	Daylily
High	<i>Liriope muscari</i>	Blue Lily Turf
High	<i>Liriope spicata</i>	Creeping Lily Turf
High	<i>Lonicera japonica</i> 'Halliana'	Hall's Honeysuckle
Low	<i>Lysimachia nummularia</i>	Moneywort
Low	<i>Nandina domestica</i>	
	'Harbor Dwarf'	Dwarf Heavenly Bamboo
High	<i>Ophiopogon japonicus</i>	Mondo Grass
Medium	<i>Osteospermum fruticosum</i>	African Daisy
High	<i>Potentilla verna</i> Spring	Cinquefoil
Low	<i>Rosmarinus officinalis</i>	Rosemary
Low	<i>Santolina virens</i>	
Low	<i>Santolina chamaecyparissus</i>	Lavender Cotton
Low	<i>Thymus citriodorus</i>	
Medium	<i>Trachelospermum asiaticum</i>	Asian Jasmine
Medium	<i>Trachelospermum jasminoides</i>	Star Jasmine
Medium	<i>Verbena</i>	
High	<i>Veronica spicata</i> 'Red Fox'	
Low	<i>Vinca minor</i> 'Bowles'	

Vines

Water Usage	Botanical Name	Common Name
High	<i>Ficus pumila</i>	Creeping Fig
Medium	<i>Gelsemium sempervirens</i>	Carolina Jessamine
Medium	<i>Hardenbergia violacea</i>	ncn
Medium	<i>Jasminum polyanthum</i>	Pink Jasmine
Medium	<i>Lonicera japonica</i> 'Purpurea'	Purple Honeysuckle
Medium	<i>Lonicera japonica</i> 'Halliana'	Hall's Honeysuckle
Medium	<i>Mandevilla laxa</i>	Chilean Jasmine
Medium	<i>Parthenocissus tricuspidata</i>	Boston Ivy
Medium	<i>Parthenocissus quinquefolia</i>	Virginia Creeper
Medium	<i>Passiflora pfordtii</i>	Blue Crown Passion Flower
Medium	<i>Rosa banksiae</i> 'Alba Plena'	Bank's White Rose
Medium	<i>Rosa banksiae</i> 'Lutea'	Bank's Yellow Rose

Medium	<i>Trachelospermum jasminoides</i>	Star Jasmine
Medium	<i>Wisteria sinensis</i> 'Blue'	Chinese Wisteria

Native and Ornamental Grasses

Water Usage	Botanical Name	Common Name
Medium	<i>Acorus</i>	Sweet Flag
Medium	<i>Arrhenatherum elatius</i> <i>bulbosum</i> 'Variegatum'	Rattlesnake Grass
Medium	<i>Calamagrostis acutifolia</i> 'Stricta'	Feather Reed Grass
Medium	<i>Carex</i> spp.	Carex
Low	<i>Festuca</i> spp.	Fescue
Medium	<i>Helictotrichon sempervirens</i>	Blue Oat Grass
Medium	<i>Miscanthus sinensis</i>	Eulalia
Low	<i>Muhlenbergia capillaris</i>	Hairy Awn Muhly
Low	<i>Muhlenbergia rigens</i>	Deer Grass
Medium	<i>Pennisetum</i> spp.	Fountain Grass
Medium	<i>Stipa gigantea</i>	Giant Feather Grass
Medium	<i>Stipa pulchra</i>	Purple Needle Grass